



TRIBE

— distribution

ACCESSORI



ACEPAC

Borse e accessori per bikepacking • Zaini

GRANITE

Multi-tool e accessori

RACER

Protezioni, guanti e accessori

KENNY RACING

Caschi • Maschere • Abbigliamento • Guanti • Protezioni

SPRAYKE

Prodotti per la pulizia e lubrificazione



ACEPAC

GRANITE

RACER

KENNY RACING

SPRAYKE



TEKTRO

SAL

AC AC

SPORT



ACERPAC

BORSE BIKEPACKING • ZAINI • ACCESSORI

HARNESSES

BAR HARNESSES & DRYBAG

HARNESSES BLACK
ART NO. | 22009



HARNESSES GREY
ART NO. | 22023

DRYBAG 16L
ART NO. | 24324



DRYBAG 8L
ART NO. | 23129

BAR HARNESSES AND TWO SIZES OF DRYBAG MAKES PERFECT COMBINATION FOR ALL YOUR ADVENTURES.

PARAMETERS:

HARNESSES:

33 x 33cm | 390g

DRYBAG 16L:

ø15 x 45cm | 195g

DRYBAG 8L:

ø18,5 x 60cm | 255g

FEATURES:

- HYPALON NON-SLIPPING STRAPS
- ALUMINIUM REINFORCEMENT BAR
- SLIPLOCK BUCKLES
- WATERPROOF ROLLER CLOSURE
- ADJUSTABLE VOLUME 8-16L
- REINFORCED EXPOSED AREAS
- EASY TO WASH TARPULIN BOTTOM
- EVA DISTANCE SPACERS
- REFLECTIVE PRINT

MATERIALS:

NYLON 6.6 RIPSTOP, TPU COATING, TARPULIN, HYPALON, ALUMINIUM, NIFCO BUCKLES, POLYPROPYLENE, HDPE

ALUMINIUM REINFORCEMENT BAR



HYPALON AND VELCRO STRAPS FOR ATTACHMENT TO THE HANDLEBAR, SECURED WITH NYLON STRAPS WITH BUCKLES. FOAM SPACERS FOR SUFFICIENT DISTANCE OF HARNESSES FROM BARS.

HYPALON LOOPS FOR SECURE BAR BAG CONNECTION

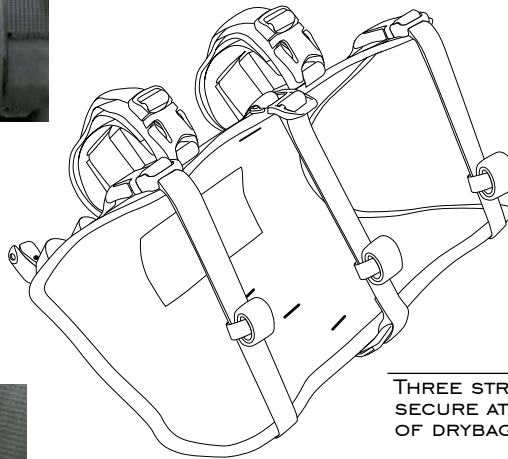

THREE STRAPS FOR SECURE ATTACHMENT OF DRYBAGS



HEAD TUBE STRAP WITH CAMLOCK BUCKLE TO AVOID HARNESSES SWING DURING A RIDE

VELCRO ON BACKSIDE OF DRYBAGS FOR SECURE FIXATION OF DRYBAG INTO HARNESSES.



NIFCO BUCKLES FOR EASY HANDLING IN CYCLING GLOVES, CAN BE USED IN FREEZING CONDITIONS DOWN TO -20°C.

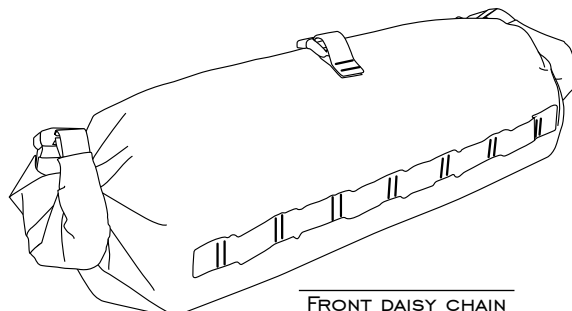

FRONT DAISY CHAIN FOR ADDITIONAL GEAR FIXING



HOOK IN TOP OF DRYBAG FOR QUICK AND SIMPLE „KNEEFREE“ CONNECTION TO HARNESSES.

ROLL CLOSURE ENSURES ENOUGH WATERPROOFNESS OF THE BAG

SADDLE HARNESS & DRYBAG

HARNESS BLACK
ART NO. | 25000



HARNESS GREY
ART NO. | 25024



DRYBAG 16L
ART NO. | 27325



DRYBAG 8L
ART NO. | 26120

SADDLE HARNESS AND TWO SIZES OF DRYBAG MAKES PERFECT COMBINATION FOR ALL YOUR ADVENTURES.

PARAMETERS:

HARNESS:

20 x 39cm | 690g

DRYBAG 16L:

ø20 x 55cm | 270g

DRYBAG 8L:

ø17 x 45cm | 210g

FEATURES:

- HYPALON NON-SLIPPING STRAPS
- ALUMINIUM REINFORCEMENT
- SLIPLOCK BUCKLES
- WATERPROOF ROLLER CLOSURE
- ADJUSTABLE VOLUME 8-16L
- REINFORCED EXPOSED AREAS
- EASY TO WASH TARPAILUN BOTTOM
- REFLECTIVE PRINT

MATERIALS:

NYLON 6.6 RIPSTOP, TPU COATING, TARPAILUN, HYPALON, ALUMINIUM, NIFCO BUCKLES, POLYPROPYLENE, HDPE

DRYBAG WITH DAISY CHAINS FOR ADDITIONAL GEAR FIXING.



CENTRAL COMPRESSION STRAP FOR SECURE DRYBAG CLOSURE FIXING.



HYPALON STRAPS FOR ATTACHMENT TO THE SEATPOST AND SADDLE RAILS. NON SLIPPERY, STRONG MATERIAL WITH VELCRO.

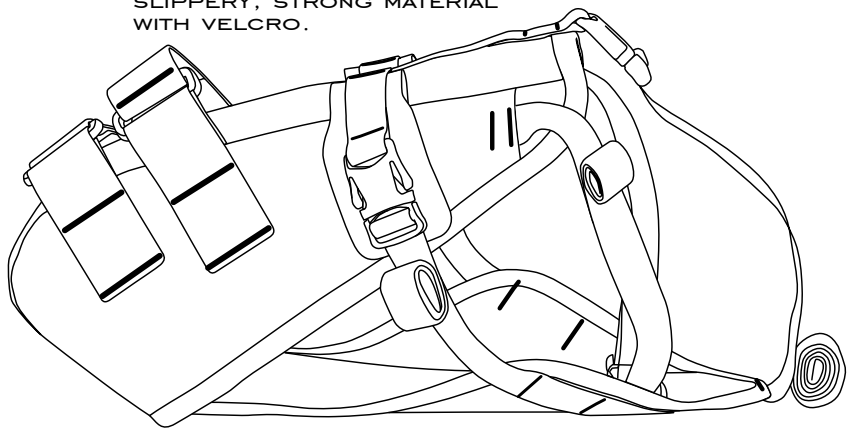

HYPALON FABRIC PART WHICH TOUCHES SEAT POST AND SADDLE RAILS FOR ADDED DURABILITY.



TARPAILUN BOTTOM REINFORCEMENT FOR EASY CLEANING AND TEAR RESISTANCE.



NIFCO BUCKLES FOR EASY HANDLING IN CYCLING GLOVES, CAN BE USED IN FREEZING CONDITIONS DOWN TO -20°C.



ROLL CLOSURE ENSURES ENOUGH WATERPROOFNESS OF THE BAG



DAISY CHAIN AT BOTTOM OF DRYBAG FOR ITS FIXATION TO BACKPACK IN CASE OF TRANSPORT.



BLACK

ART NO. 101301



GREY

ART NO. 101325

LARGE HANDLEBAR BAG FOR TRANSPORT OF EASILY COMPRESSIBLE EQUIPMENT, THANKS TO ITS DIMENSIONS ALSO SUITABLE FOR TRANSPORT OF SLEEPING EQUIPMENT - TENT, SLEEPING BAG, MAT, ETC.

PARAMETERS:

ø 18,5 x [30-60]cm
[8-16]L
485g

FEATURES:

- EVA DISTANCE SPACERS
- ALUMINIUM REINFORCEMENT BAR
- REMOVABLE WATERPROOF LINER
- SLIPLOCK BUCKLES
- DOUBLE-SIDED ROLLER CLOSURE
- ADJUSTABLE VOLUME 8-16L
- REINFORCED EXPOSED AREAS
- EASY TO WASH TARPAULIN BOTTOM
- REFLECTIVE PRINT

MATERIALS:

NYLON 6.6 RIPSTOP, PU COATING, TARPAULIN, HYPALON, ALUMINIUM, NIFCO BUCKLES, POLYPROPYLENE



CENTRAL STRAP WITH CAMLOK BUCKLE FOR FIXATION OF THE BAG TO THE HEAD TUBE OF BIKE FRAME. EXPOSED AREAS WHERE THE BAG TOUCHES THE HEAD TUBE AND BRAKE LEVERS ARE REINFORCED WITH A SECOND LAYER OF DURABLE NYLON 6.6 FABRIC.



EVA FOAM DISTANCE SPACERS AND ALUMINIUM REINFORCEMENT KEEP THE BAG AWAY FROM THE HANDLEBARS TO PROTECT THE BRAKE LEVERS AND THEIR SUPPLY HOSES.

SECURE ATTACHMENT TO THE HANDLEBARS WITH NON-SLIP HYPALON STRAPS WITH WIDE VELCRO FASTENING IS SECURED BY STRAPS WITH BUCKLES WITH ANTI SLIP LOCK FUNCTION TO AVOID BAG MOVEMENT DURING A RIDE.



DOUBLE-SIDED ROLLER CLOSURE WITH NIFCO BUCKLES (~20°C), FOR EASY GLOVE CONTROL, CAN BE ROLLED LIKE A CLASSIC DRYBAG BY CLOSING THE BUCKLES AT THE BAG ENTRANCE.

THE BOTTOM PART OF THE BAG COVERED BY EASY-TO-CLEAN TARPAULIN FABRIC. HORIZONTAL STRAP CHAIN AT THE BOTTOM OF THE BAG TO ATTACH IT TO THE BACKPACK FOR EASY TRANSPORTATION OF THE BAG IN RUGGED TERRAIN.

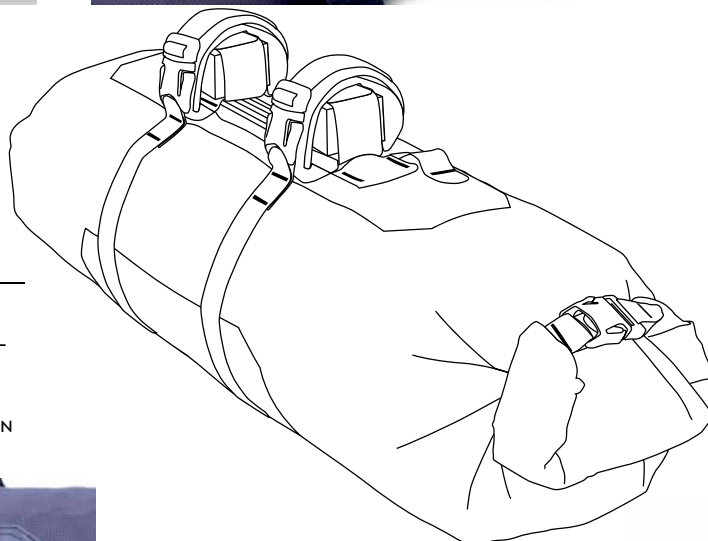

THE BAG HAS A REMOVABLE WATERPROOF LINER (COATED NYLON RIPSTOP FABRIC, PU 5000MM WITH TAPED SEAMS), WHICH GUARANTEES TO KEEP THE CARRIED STUFF DRY.



BAR BAG



BLACK
ART NO. 121002



GREY
ART NO. 121026

SMALL HANDLEBAR BAG FOR TRANSPORT OF VARIOUS QUICKLY AVAILABLE EQUIPMENT, FOR EXAMPLE CAMERA, PHONE, EVERYDAY NEEDS.

PARAMETERS:

25 x 12 x 16cm
5L
270g

FEATURES:

- HYPALON NON SLIPPING STRAPS
- REMOVABLE WATERPROOF LINER
- SLIPLOCK BUCKLES
- WATERPROOF ROLLER CLOSURE
- WATER RESISTANT YKK TWO WAY ZIPPER
- REFLECTIVE PRINT

MATERIALS:

NYLON 6.6 RIPSTOP, PU COATING, HYPALON, NIFCO BUCKLES, POLYPROPYLENE, YKK ZIPPERS

PAIR OF VELCRO AND HYPALON STRAPS ENABLE TO CONNECT BAR BAG TO HANDLEBARS DIRECTLY WITHOUT BAR ROLL.



DRYBAG IS FIXED INTO BAG BY VELCRO FOR EASIER ROLLING.



SIDE MESH POCKETS SUITABLE FOR QUICKLY ACCESSIBLE EQUIPMENT OR TRASH



HEAD TUBE STRAP WITH CAMLOCK BUCKLE TO AVOID HARNESS SWING DURING A RIDE.

YKK WATER RESISTANT ZIPPER WITH TWO SLIDERS FOR EASIER STUFF REACH.

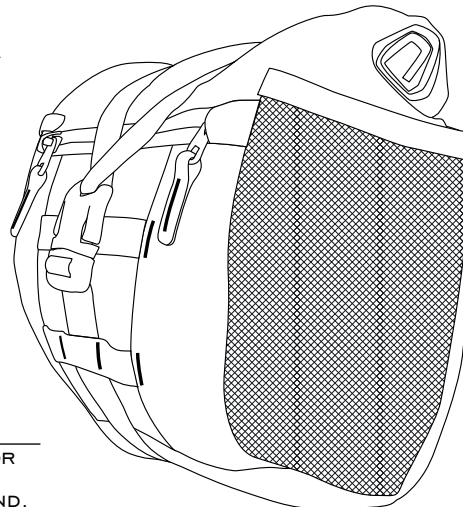

ROLL CLOSURE ENSURES WATERPROOFNESS OF THE BAG



THE BAG HAS A REMOVABLE WATERPROOF LINER (COATED NYLON RIPSTOP FABRIC, PU 5000MM WITH TAPED SEAMS), WHICH GUARANTEES TO KEEP THE CARRIED STUFF DRY.



NIFCO BUCKLES FOR EASY HANDLING IN CYCLING GLOVES AND. THOSE BUCKLES CAN BE USED IN FREEZING CONDITIONS UP TO -20°C.

THE BAG CAN BE ATTACHED DIRECTLY TO HANDLEBARS OR TO THE BAR ROLL, USING SPECIAL BUCKLES WHICH ARE INCLUDED IN THE BAR BAG



PAIR OF DAISY CHAINS IN FRONT OF BAG FOR ADDITIONAL GEAR OR FLASHLIGHT FIXING.

BIKE BOTTLE BAG



BLACK
ART NO. 131001



GREY
ART NO. 131025

SMALL HANDLEBAR BAG MADE TO FIT THE STANDARD BIKE BOTTLE. OF COURSE YOU CAN USE IT FOR DIFFERENT PURPOSES SUCH AS SNACKS OR OTHER STUFF YOU KEEP.

PARAMETERS:

Ø9 x [13-17]cm
65g

FEATURES:

- EASY TO FIX BY VELCRO STRAPS
- SIDE MESH POCKET
- ELASTIC STRING WITH STOPPER CLOSURE
- REFLECTIVE LOGO
- HIGH VISIBILITY LINING FOR EASIER TRANSPORTED GEAR ORGANISATION

MATERIALS:

NYLON 6.6 RIPSTOP, PU COATING, POLYPROPYLENE WEBBING, HIGH VISIBILITY LINING

SIDE „TRASH MESH POCKET“



STRAP WITH CAMLOCK BUCKLE TO FIX THE BOTTOM TO THE FORK CROWN.



STRING WITH STOPPER CLOSURE.

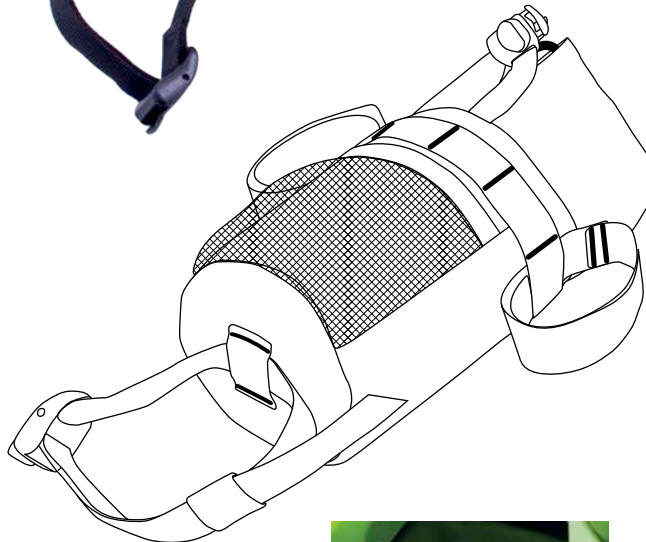

THE VELCRO STRAPS CAN BE MOVED AROUND THE BAG THANKS TO THE STRAP LADDER.

ELASTIC BAND HOLDS THE BOTTLE IN PLACE AND CLOSES THE BAG.



THE HOLE IN THE BOTTOM OF THE BAG TO SPILL THE WATER IN CASE YOU WILL CATCH SOME IN RAINY WEATHER



FAT BOTTLE BAG



BLACK
ART NO. I 32008



GREY
ART NO. I 32022

SMALL HANDLEBAR BAG MADE TO FIT THE FAT 1 L TRITAN BOTTLE. EVEN MORE SPACE FOR YOUR SNACKS OR OTHER STUFF YOU KEEP.

PARAMETERS:
Ø 10 x [14.5-19]cm
75g

FEATURES:

- EASY TO FIX BY VELCRO STRAPS
- TRASH MESH POCKET
- ELASTIC STRING WITH STOPPER CLOSURE
- REFLECTIVE LOGO
- HIGH VISIBILITY LINING FOR EASIER TRANSPORTED GEAR ORGANISATION

MATERIALS:

NYLON 6.6 RIPSTOP, PU COATING, POLYPROPYLENE, HIGH VISIBILITY LINING

SIDE „TRASH MESH POCKET“



STRAP WITH CAMLOK BUCKLE TO FIX THE BOTTOM TO THE FORK CROWN.



STRING WITH STOPPER CLOSURE.

ELASTIC BAND HOLDS THE BOTTLE IN PLACE AND CLOSES THE BAG.



THE HOLE IN THE BOTTOM OF THE BAG TO SPILL THE WATER IN CASE YOU WILL CATCH SOME IN RAINY WEATHER



VELCRO STRAPS FOR ATTACHMENT TO THE HANDLES. CAN BE MOVED AROUND TO FIT YOUR NEEDS.



SADDLE

SADDLE BAG



BLACK
ART NO. I 03305



GREY
ART NO. I 03329

LARGE SADDLE BAG FOR TRANSPORT OF EASILY COMPRESSIBLE EQUIPMENT, SUCH AS CLOTHING.

PARAMETERS:

ø21 x [36-58]cm
16L
690g

FEATURES:

- HYPALON NON-SLIPPING STRAPS
- REMOVABLE WATERPROOF LINER
- SLIPLOCK BUCKLES
- WATERPROOF ROLLER CLOSURE
- ADJUSTABLE VOLUME 8-16L
- REINFORCED EXPOSED AREAS
- EASY TO WASH TARPAILUN BOTTOM
- REFLECTIVE PRINT

MATERIALS:

NYLON 6.6 RIPSTOP, PU COATING, TARPAILUN, HYPALON, HDPE, NIFCO BUCKLES, POLYPROPYLENE

CENTRAL COMPRESSION STRAP FOR EVEN MORE SECURE ROLL CLOSURE. TOP DAISY CHAINS FOR ADDITIONAL GEAR FIXING POSSIBILITY



NIFCO BUCKLES FOR EASY HANDLING IN CYCLING GLOVES, CAN BE USED IN FREEZING CONDITIONS DOWN TO -20°C.

HYPALON STRAPS FOR ATTACHMENT TO THE SEATPOST AND SADDLE STRUTS. NON SLIPPERY, STRONG MATERIAL WITH VELCRO.



HYPALON FABRIC PART WHICH TOUCHES SEAT POST AND SADDLE RAILS FOR ADDED DURABILITY.

SLIPLOCK BUCKLES FOR SAFE SADDLE CONNECTION.

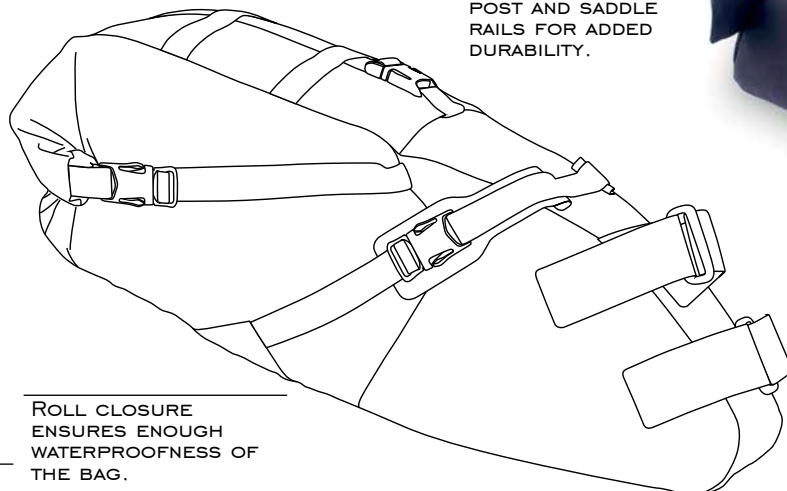

HDPE BOARD REINFORCEMENT IN SADDLE AREA TO KEEP ITS SHAPE.

THE BAG HAS A REMOVABLE WATERPROOF LINER (COATED NYLON RIPSTOP FABRIC, PU 5000MM WITH TAPED SEAMS), WHICH GUARANTEES TO KEEP THE CARRIED STUFF DRY.



ROLL CLOSURE ENSURES ENOUGH WATERPROOFNESS OF THE BAG.

HDPE BOARD REINFORCED BOTTOM FOR BETTER BAG STABILITY.

TARPAILUN BOTTOM REINFORCEMENT FOR EASY CLEANING AND TEAR RESISTANCE.

DAISY CHAIN AT BOTTOM OF BAG FOR ITS FIXATION TO BACKPACK IN CASE OF TRANSPORT.



FRAME ZIP FRAME BAG



BLACK L
ART NO. | 29305



GREY M
ART NO. | 28223



GREY L
ART NO. | 29329



BLACK M
ART NO. | 28209

UNIVERSAL FRAME BAG IN TWO SIZES, M AND L. THE BAG IS EQUIPPED WITH WATER RESISTANT YKK ZIPPER WITH TWO SLIDERS. THE CIRCUMFERENCE OF THE BAG IS PADDED TO PROTECT THE FRAME. INSIDE FRAME POSITION IS IDEAL FOR HEAVY GEAR TRANSPORT.

ACEPAC

PARAMETERS:

[40/48] x 6 x [14/17]cm
[3.5/4]L
265g

FEATURES:

- LONG VELCRO STRAPS MEANT TO BE CUT EXACTLY TO YOUR FRAME
- PADDED CIRCUMFERENCE WALLS FOR BETTER FRAME FIT AND SOUND FREE RIDES.
- WATER RESISTANT YKK ZIPPER
- REFLECTIVE LOGO
- INNER MESH POCKETS

MATERIALS:

NYLON 6.6 RIPSTOP, PU COATING, NIFCO BUCKLES, YKK ZIPPERS, HIGH VISIBLE LINING

HIGH VISIBLE LINING INSIDE BAG.



INNER MESH POCKETS FOR BETTER GEAR ORGANISATION INSIDE BAG.

YKK ZIPPER WITH TWO SLIDERS FOR EASIER BAG OPENING.



CAMELBAG HOSE OUTLET

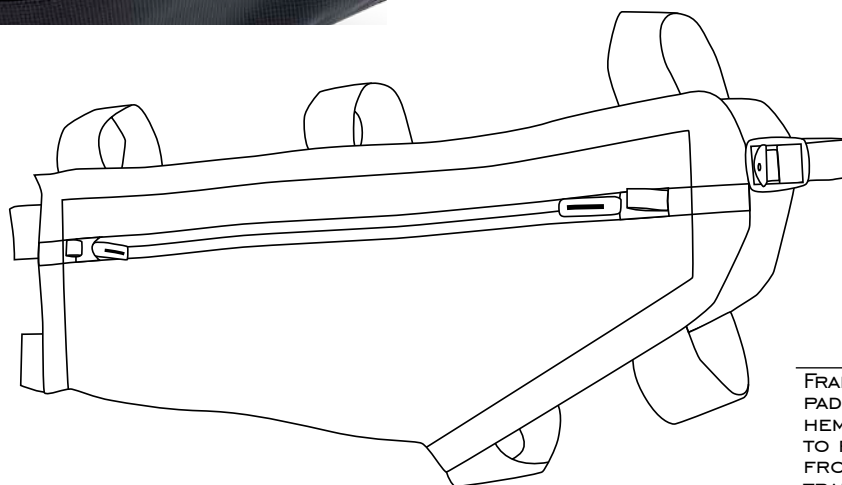

REFLECTIVE PRINT ON SIDES



FRAME TOUCHING SIDES ARE PADDED AND EQUIPPED WITH HEMS TO FIT PROPERLY AND TO PROTECT THE FRAME FROM SCRATCHING BY TRANSPORTED CARGO

SEVEN LONG VELCRO STRAPS TO FIT AS MANY FRAMES AS POSSIBLE. CUT OFF THE REMAINING PART.



STRAP WITH CAMLOCK BUCKLE TO ATTACH TO THE HEAD TUBE.



FUEL BAG M

BLACK
ART NO. I 30202



GREY
ART NO. I 30226

FUEL BAG TO STORE ALL THE NECESSARY WIDGETS AND SNACKS YOU NEED TO HAVE THE FAST ACCESS.

PARAMETERS:

19 x 6 x 10cm
0.8L
110g

FEATURES:

- LONG VELCRO STRAPS MEANT TO BE CUT EXACTLY TO YOUR FRAME
- PADDED CIRCUMFERENCE
- 2 WATER RESISTANT YKK ZIPPERS
- REFLECTIVE LOGO
- TWO OUTER SIDE MESH POCKETS
- TWO INNER MESH POCKETS

MATERIALS:

NYLON 6.6 RIPSTOP, PU COATING, NIFCO BUCKLES, YKK ZIPPERS, POLYPROPYLENE, HIGH VISIBLE LINING

DOUBLE WATER RESISTANT YKK ZIPPER FOR COMFORTABLE ACCESS AND PROTECTION OF YOUR STUFF



NON SLIP HYPALON LOOPS ON THE SIDES OF ZIPPER FOR EASY HANDLING

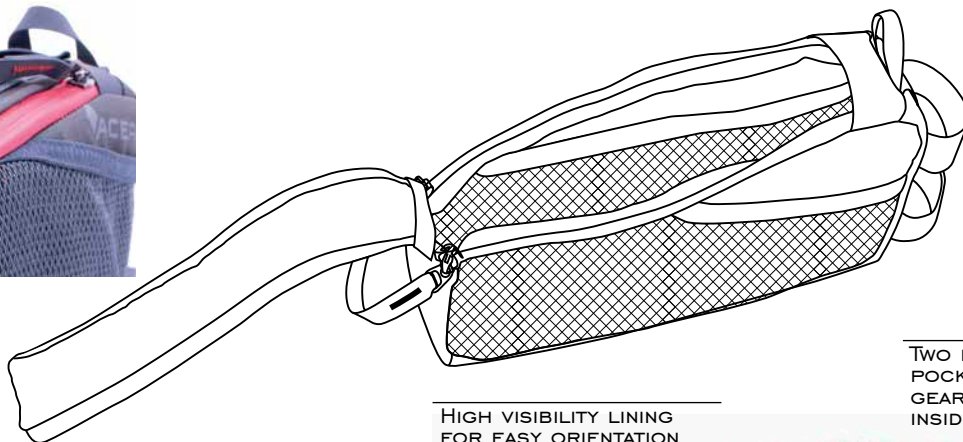

LONG VELCRO STRAPS TO FIT AS MANY FRAMES AS POSSIBLE CAN BE POSITIONED. CUT OFF THE REMAINING PART.

TWO SIDE MESH POCKETS



HIGH VISIBLE LINING FOR EASY ORIENTATION INSIDE BAG.



TWO INNER SIDE MESH POCKETS FOR BETTER GEAR ORGANISATION INSIDE BAG.

FUEL BAG L



GREY
ART NO. 107327



BLACK
ART NO. 107303

FUEL BAG TO STORE ALL THE NECESSARY WIDGETS AND SNACKS YOU NEED TO HAVE THE FAST ACCESS. TWO INNER PADDED PARTITONS CAN BE ADJUSTED BY OR REMOVED.

PARAMETERS:

26 x 6 x 10cm
1.2L
135g

FEATURES:

- LONG VELCRO STRAPS MEANT TO BE CUT EXACTLY TO YOUR FRAME
- PADDED CIRCUMFERENCE
- 2 WATER RESISTANT YKK ZIPPERS
- REFLECTIVE LOGO
- TWO OUTER SIDE MESH POCKETS
- TWO PADDED ADJUSTABLE PARTITIONS

MATERIALS:

NYLON 6.6 RIPSTOP, PU COATING, NIFCO BUCKLES, YKK ZIPPERS, POLYPROPYLENE, HIGH VISIBILITY LINING

NON SLIP HYPALON LOOPS ON THE SIDES OF ZIPPER FOR EASY HANDLING



DOUBLE WATER RESISTANT YKK ZIPPER FOR COMFORTABLE ACCESS AND PROTECTION OF YOUR STUFF



LONG VELCRO STRAPS TO FIT AS MANY FRAMES AS POSSIBLE CAN BE POSITIONED. CUT OFF THE REMAINING PART.



TWO SIDE MESH POCKETS

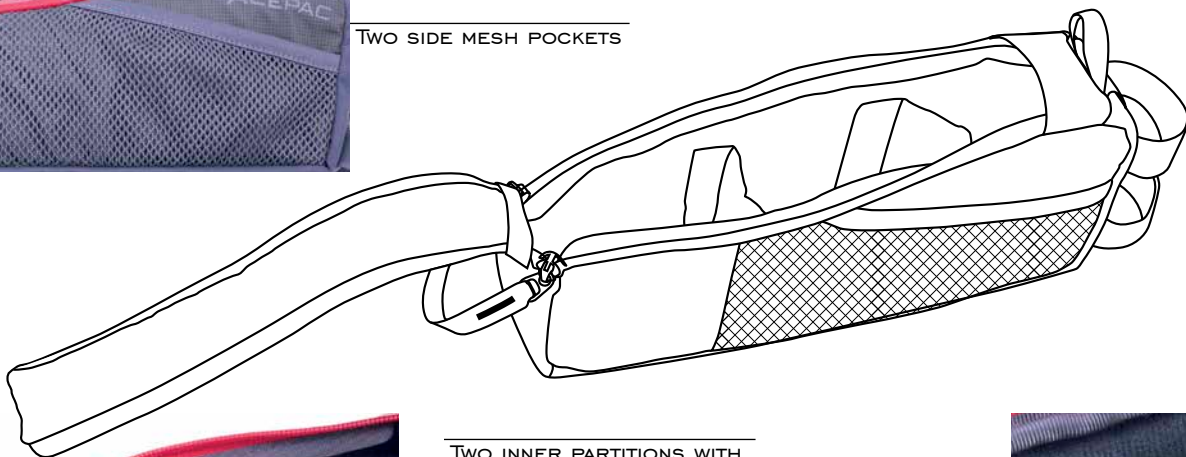

TWO INNER PARTITIONS WITH VELCRO HEMS CAN BE ADJUSTED OR PUT OUT BY YOUR NEEDS



BRUSHED INNER SIDES TO PROTECT YOUR STUFF FROM SCRATCHING



TUBE BAG



GREY

ART NO. I 33029

BLACK

ART NO. I 33005

A LITTLE BAG MEANT TO STORE ROLLED UP SPARE TUBE AND THE ESSENTIAL TOOLS. WATER RESISTANT YKK ZIPPER SEEMS TO BE OVERKILL FOR JUST THE TUBE, BUT WE WANT IT TO BE USABLE FOR MORE STUFF.

PARAMETERS:

12 x 6 x 10cm
0.7L
60g

FEATURES:

- LONG VELCRO STRAPS MEANT TO BE CUT EXACTLY TO YOUR FRAME
- PADDED CIRCUMFERENCE
- WATER RESISTANT YKK ZIPPER
- REFLECTIVE LOGO
- TWO INNER MESH POCKETS

MATERIALS:

NYLON 6.6 RIPSTOP, PU COATING, YKK ZIPPERS, POLYPROPYLENE, HIGH VISIBILITY LINING

MULTIPLE CONNECTION POSSIBILITIES BY WEBBING LADDER.



TWO INNER MESH POCKETS



WATER RESISTANT YKK ZIPPER



LONG VELCRO STRAPS TO FIT AS MANY FRAMES AS POSSIBLE CAN BE POSITIONED. CUT OFF THE REMAINING PART.

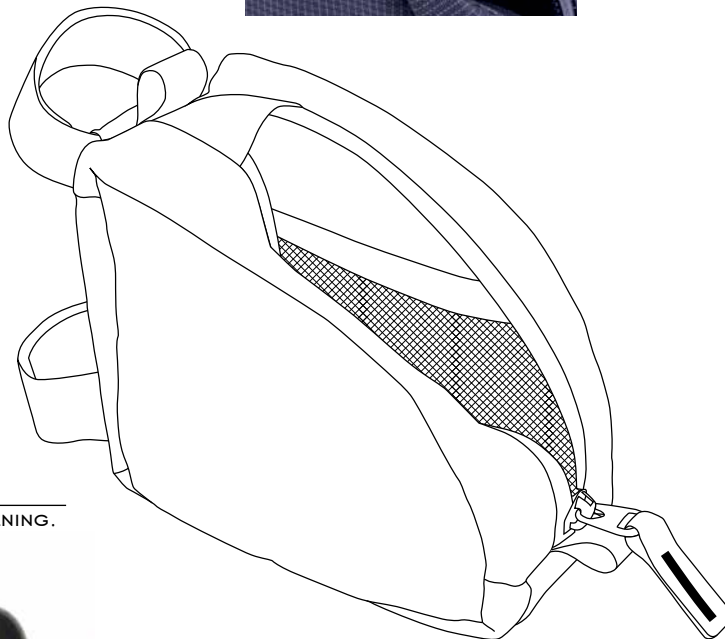

HIGH VISIBILITY LINING



HYPALON LOOPS FOR EASIER OPENING.

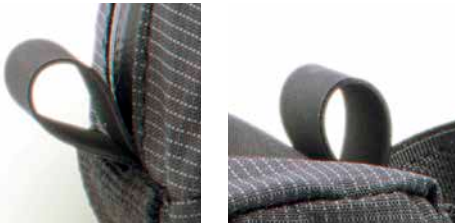

REFLECTIVE PRINT ON SIDES



MINIMA BAG



GREY
ART NO. I 34026



BLACK
ART NO. I 34002



THIS BAG IS MEANT TO BE ATTACHED TO THE FORK OR FRAME. MADE FOR THE MINIMA POT OR MINIMA SET COOKING SETS. ROLL CLOSURE.

PARAMETERS:

ø 12 x 14cm
1.5L
85g

FEATURES:

- HYPALON NON SLIP STRAPS
- SLIPLOCK NIFCO BUCKLES
- ROLLER CLOSURE
- PADDED WALLS
- REFLECTIVE PRINT
- ROLL CLOSURE

MATERIALS:

NYLON 6.6 RIPSTOP, PU COATING, HYPALON, NIFCO BUCKLES, POLYPROPYLENE, HIGH VISIBILITY LINING



PAIR OF COMPRESSION STRAPS FOR ROCK SOLID BAG FIXATION TO FRAME OR FORK



WATER RESISTANT ROLLER CLOSING SYSTEM ALLOWS YOU TO ADJUST THE VOLUME OF THE BAG



ATTACHMENT STRAPS ARE MADE OF THREE LAYERS, OF HYPALON, VELCRO AND STRAP WITH BUCKLE TO SECURELY FIX THE BAG



HI VISIBILITY LINING INSIDE BAG FOR EASIER ORIENTATION PADDED WALLS PROTECT YOUR FRAME AND EQUIPMENT



THE HOLE IN THE BOTTOM OF THE BAG TO SPILL THE WATER IN CASE YOU WILL CATCH SOME IN RAINY WEATHER

TOOL WALLET



GREY
ART NO. I 35023

FOLDABLE POUCH TO STORE ALL THE NECESSARY TOOLS. THANKS TO THE HYPALON STRAPS CAN BE ATTACHED TO THE FRAME OR SADDLE RAILS.

PARAMETERS:
22.5 x 15cm
0.16g

- FEATURES:**
- HYPALON NON-SLIPPING STRAP
 - REINFORCED EXPOSED AREAS
 - PRACTICAL BINDER FOR ALL YOUR TOOLS
 - LOOP FOR THE TAILLIGHT
 - REFLECTIVE PRINT

MATERIALS:
NYLON 6.6 RIPSTOP, PU COATING, HYPALON, NIFCO, HIGH VISIBILITY LINING

THREE SMALL POCKETS WITH VELCRO CLOSURE, TWO PAIRS OF ELASTIC LOOPS

THREE POCKETS SECURED BY FOLDING



LOOP FOR THE TAILLIGHT



HYPALON STRAP WITH VELCRO TO ATTACH TO THE BIKE FRAME

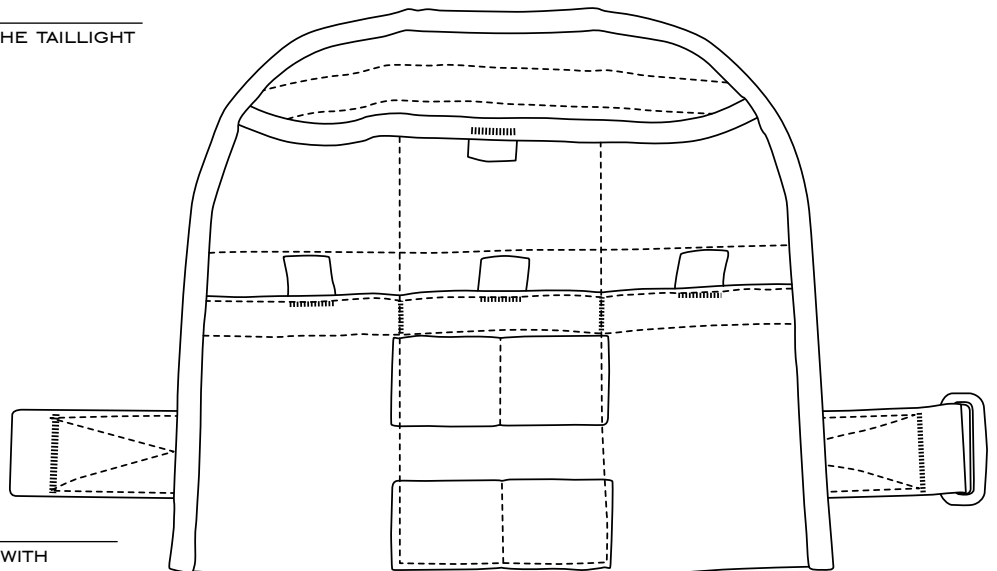

TUBE WRAP



GREY
ART NO. I 36020

HYPALON STRAP SYSTEM TO PACK THE SPARE TUBE TOGETHER WITH MOUNTING LEVERS AND ATTACH IT TO THE FRAME. PLUS LOOP FOR THE TAILLIGHT.

PARAMETERS:
22.5 x 15cm
0.16g

- FEATURES:**
- HYPALON NON-SLIPPING STRAPS
 - LOOPS FOR THE MOUNTING LEVERS
 - LOOP FOR THE TAILLIGHT

MATERIALS:
HYPALON, NIFCO

HYPALON MAKES THE WRAP STRONG AND NON SLIPPING



LOOP FOR THE TAILLIGHT



WIDE HYPALON STRAP PROTECTS TUBE FROM DAMAGE.

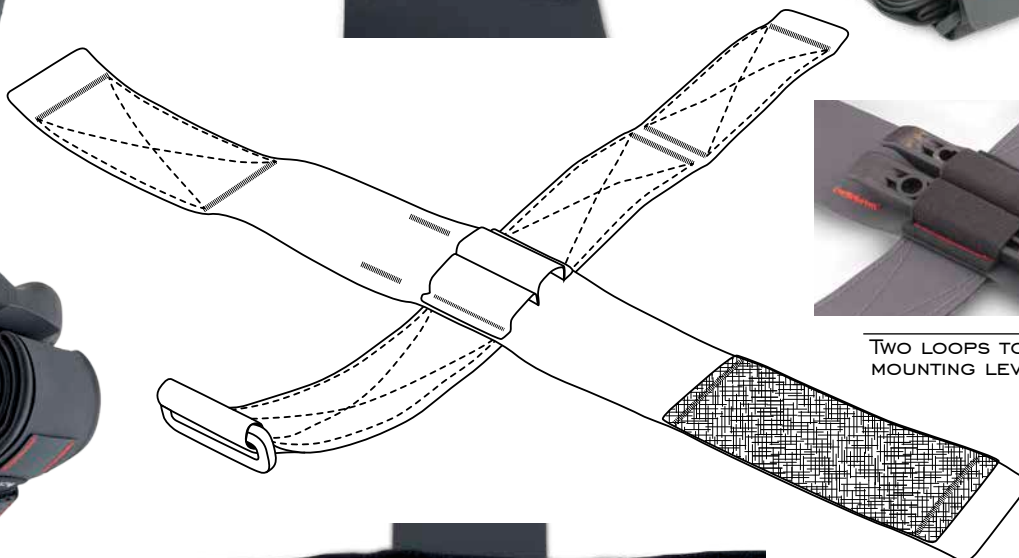

TWO LOOPS TO FIT THE MOUNTING LEVERS



HUGE VELCRO CONNECTIONS ENSURES THE SECURITY OF THE WRAP IN VERY HARSH CONDITIONS

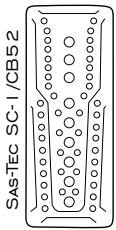

COMPATIBLE



BLACK
ART NO. 207607



GREY
ART NO. 207621

FEATURES:

- RAINCOVER INCLUDED
- CARRY MORE STRAP SYSTEM
- LCG - LOW CENTER OF GRAVITY
- TOOLS ORGANISER
- GOGGLES POCKET
- CLIP ON KEYCHAIN
- E3D VENTED BACK PANEL
- SPLITTED SHOULDER STRAPS
- SIDE ENTRY
- PADDED LAPTOP POCKET
- REFLECTIVE DETAILS
- FLASHLIGHT LOOP
- EXPANDABLE VOLUME
- STERNUM STRAP WHISTLE
- ADJUSTABLE STERNUM STRAP HEIGHT
- POSSIBILITY TO HIDE HIPBELT INTO THE BACKPANEL
- COMPATIBILITY: SAS-TEC SC-1 CB52 SPINE PROTECTOR, 8L BAR DRYBAG, HELMET HOLDER, H2O BLADDER, BATTERY CASE

PARAMETERS:

48 x 28 x 19 cm
800 g

MATERIALS:

NYLON 6.6, NYLON ROBIC RIPSTOP, NIFCO BUCKLES, YKK ZIPPERS

BACKPACK WITH EXPANDABLE VOLUME SUITABLE FOR BOTH WILDERNESS AND URBAN ADVENTURES.

DEVELOPED WITH PROFESSIONAL FREERIDER RICHARD 'GASPI' GASPEROTTI.



SAS-TEC SPINE PROTECTOR AND BATTERY CASE COMPATIBLE



SIDE ENTRY WITH MESH BOTTLE POCKET



VARIOUS HELMET FIXING POSSIBILITIES



GOGGLES POCKET WITH EMERGENCY PRINT

SPLITTED SHOULDER STRAPS

LOW CENTER OF GRAVITY DESIGN WITH ADJUSTABLE LCG BAR



E3D VENTED BACK PANEL

SIDE POCKET WITH RAINCOVER, BOTTLE COMPATIBLE



POSITIONABLE STERNUM STRAP WITH EMERGENCY WHISTLE



8L BAR DRYBAG COMPATIBLE

THANKS FOR THE INCLUDED STRAPS, YOU CAN EASILY ATTACH MORE EQUIPMENT

HIPBELT IS HIDEABLE INTO THE BACK SYSTEM

FLITE 20

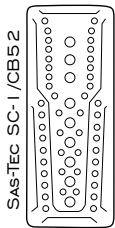

COMPATIBLE



GREY
ART NO. 206723



BLACK
ART NO. 206709

FEATURES:

- RAINCOVER INCLUDED
- CARRY MORE STRAP SYSTEM
- HIDE STRAP SYSTEM
- LCG - LOW CENTER OF GRAVITY
- TOOLS ORGANISER
- GOGGLES POCKET
- CLIP ON KEYCHAIN
- E3D VENTED BACK PANEL
- SPLITTED SHOULDER STRAPS
- SWAY HIPBELT FOR MAXIMUM CONTROL
- FULLFACE HELMET FIXING STRAPS
- REFLECTIVE DETAILS
- FLASHLIGHT LOOP
- STERNUM STRAP WHISTLE
- ADJUSTABLE STERNUM STRAP HEIGHT
- HIBBELT POCKETS
- COMPATIBILITY: SAS-TEC SC-1 / CB52 SPINE PROTECTOR, BAR BAG, 8L BAR DRYBAG, HELMET HOLDER, H2O BLADDER, BATTERY CASE

PARAMETERS:

48 x 28 x 22 CM
910 G

MATERIALS:

NYLON 6.6, NYLON ROBIC, RIPSTOP, YKK ZIPPERS, NIFCO BUCKLES

DO YOU HAVE BULKY STUFF, BUT NEED MINIMAL RIDE EXPERIENCE IMPACT? THIS PACK IS YOUR SOLUTION. ROOMY MAIN CHAMBER AND ELABORATE COMPARTMENT MANAGEMENT WILL ALLOW YOU TO HOLD ALL STUFF IN ITS PLACE DURING YOUR WILD TRIPS.

SAS-TEC SPINE PROTECTOR, H2O BLADDER AND BATTERY CASE COMPATIBLE



HELMET HOLDER COMPATIBLE, FULLFACE HELMET FIXING STRAPS



SPLITTED SHOULDER STRAPS

LOW CENTER OF GRAVITY DESIGN WITH ADJUSTABLE LCG BAR



BAR BAG AND 8L BAR DRYBAG COMPATIBLE

TOOLS ORGANISER, GOGGLES POCKET



BATTERY CASE COMPATIBLE



POSITIONABLE STERNUM STRAP WITH EMERGENCY WHISTLE

E3D VENTED BACK PANEL



SIDE POCKET WITH RAINCOVER, BOTTLE COMPATIBLE

SWAY HIPBELT WITH POCKETS

EMERGENCY PRINT



HIDE STRAP SYSTEM

FLITE 15

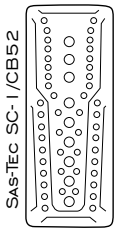

COMPATIBLE



BLACK
ART NO. 206600



GREY
ART NO. 206624

FEATURES:

- RAINCOVER INCLUDED
- CARRY MORE STRAP SYSTEM
- HIDE STRAP SYSTEM
- LCG - LOW CENTER OF GRAVITY
- TOOLS ORGANISER
- GOGGLES POCKET
- CLIP ON KEYCHAIN
- E3D VENTED BACK PANEL
- SPLITTED SHOULDER STRAPS
- SWAY HIPBELT FOR MAXIMUM CONTROL
- FULLFACE HELMET FIXING STRAPS
- REFLECTIVE DETAILS
- FLASHLIGHT LOOP
- STERNUM STRAP WHISTLE
- ADJUSTABLE STERNUM STRAP HEIGHT
- HIBBELT POCKETS
- COMPATIBILITY: SAS-TEC SC-1 / CB52 SPINE PROTECTOR, BAR BAG, 8L BAR DRYBAG, HELMET HOLDER, H2O BLADDER, BATTERY CASE

PARAMETERS:

48 x 27 x 18 cm
880 g

MEDIUM VOLUME BACKPACK TO CARRY ALL THE NECESSARY STUFF FOR YOUR WHOLE DAY IN A SADDLE ADVENTURES.

MATERIALS:

NYLON 6.6, NYLON ROBIC, RIPSTOP, YKK ZIPPERS, NIFCO BUCKLES



POSITIONABLE LCG BAR AND H2O BLADDER OUTLET



ADJUSTABLE STERNUM STRAP WITH EMERGENCY WHISTLE



E3D VENTED BACK PANEL



SPLITTED SHOULDER STRAPS

SPLITTED SHOULDER STRAPS

LOW CENTER OF GRAVITY DESIGN WITH ADJUSTABLE LCG BAR

POSITIONABLE STERNUM STRAP WITH EMERGENCY WHISTLE

E3D VENTED BACK PANEL



RAINCOVER INCLUDED



SWAY HIPBELT FOR MAXIMUM COMFORT



SIDE POCKET WITH RAINCOVER, BOTTLE COMPATIBLE

SWAY HIPBELT WITH POCKETS

FLITE 10

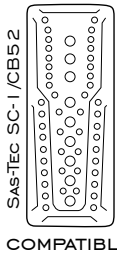

GREY
ART NO. 206525



BLACK
ART NO. 206501

FEATURES:

- RAINCOVER INCLUDED
- CARRY MORE STRAP SYSTEM
- HIDE STRAP SYSTEM
- LCG - LOW CENTER OF GRAVITY
- TOOLS ORGANISER
- GOGGLES POCKET
- CLIP ON KEYCHAIN
- E3D VENTED BACK PANEL
- SPLITTED SHOULDER STRAPS
- SWAY HIPBELT FOR MAXIMUM CONTROL
- FULLFACE HELMET FIXING STRAPS
- REFLECTIVE DETAILS
- FLASHLIGHT LOOP
- STERNUM STRAP WHISTLE
- ADJUSTABLE STERNUM STRAP HEIGHT
- HIBBELT POCKETS
- COMPATIBILITY: SAS-TEC SC-1 / CB52 SPINE PROTECTOR, BAR BAG, 8L BAR DRYBAG, HELMET HOLDER, H2O BLADDER, BATTERY CASE

PARAMETERS:

45 x 22 x 16 cm
780 g

MATERIALS:

NYLON 6.6, NYLON ROVIC, RIPSTOP, YKK ZIPPERS, NIFCO BUCKLES

MINIMALISTIC VARIANT OF FULLY EQUIPPED FLITE BACKPACK. DUE TO SLIGHTLY SHORTER BACKPANEL WELL SUITABLE ALSO FOR LADIES.



REFLECTIVE DETAILS FOR HIGHEST SAFETY, FLASHLIGHT LOOP



BRUSHED POCKET FOR STORING GOGGLES



HIPBELT POCKETS



CLIP ON KEYCHAIN

SPLITTED SHOULDER STRAPS

LOW CENTER OF GRAVITY DESIGN WITH ADJUSTABLE LCG BAR



E3D VENTED BACK PANEL

POSITIONABLE STERNUM STRAP WITH EMERGENCY WHISTLE

SIDE POCKET WITH RAINCOVER, BOTTLE COMPATIBLE



BIKE BOTTLE POCKET



ZIPPER POCKET WITH EMERGENCY PRINT

SWAY HIPBELT WITH POCKETS

FLITE 6 JR

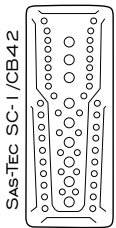

COMPATIBLE



BLACK
ART NO. 206303



GREY
ART NO. 206327

FEATURES:

- RAINCOVER INCLUDED
- HIDE STRAP SYSTEM
- GOGGLES POCKET
- E3D VENTED BACK PANEL
- FULLFACE HELMET FIXING STRAPS
- REFLECTIVE DETAILS
- FLASHLIGHT LOOP
- STERNUM STRAP WHISTLE
- ADJUSTABLE STERNUM STRAP HEIGHT
- POSSIBILITY TO HIDE HIPBELT INTO THE BACKPANEL
- COMPATIBILITY: SAS-TEC SC-1/CB42 SPINE PROTECTOR, HELMET HOLDER, H2O BLADDER, BATTERY CASE

PARAMETERS:

38 x 20 x 15 cm
460 g

JUNIOR BACKPACK WITH THE MOST IMPORTANT BIKE BACKPACK FEATURES, SUITABLE NOT ONLY FOR RIDING DUE TO HIDEABLE WAIST STRAP.

MATERIALS:

NYLON 6.6, NYLON ROBIC, RIPSTOP, YKK ZIPPERS, NIFCO BUCKLES



H2O BLADDER HOSE OUTLET



BIKE BOTTLE POCKET



FULLFACE HELMET FIXING STRAPS, HELMET HOLDER COMPATIBLE



GOGGLES POCKET

PERFORATED SHOULDER STRAPS

LOW CENTER OF GRAVITY DESIGN WITH ADJUSTABLE LCG BAR



HIDE STRAP SYSTEM

H2O BLADDER COMPATIBLE



POSITIONABLE STERNUM STRAP WITH EMERGENCY WHISTLE



E3D VENTED BACK PANEL

SIDE POCKET WITH RAINCOVER, BOTTLE COMPATIBLE

HIPBELT CAN BE HIDDEN INTO THE BACKPANEL

EDGE 7

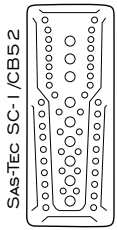

COMPATIBLE



GREY
ART NO. 205429



BLACK
ART NO. 205405

FEATURES:

- RAINCOVER INCLUDED
- CARRY MORE STRAP SYSTEM
- HIDE STRAP SYSTEM
- LCG - LOW CENTER OF GRAVITY
- TOOLS ORGANISER
- GOGGLES POCKET
- CLIP ON KEYCHAIN
- E3D VENTED BACK PANEL
- SPLITTED SHOULDER STRAPS
- FULLFACE HELMET FIXING STRAPS
- REFLECTIVE DETAILS
- FLASHLIGHT LOOP
- STERNUM STRAP WHISTLE
- ADJUSTABLE STERNUM STRAP HEIGHT
- COMPATIBILITY: SAS-TEC SC-1/CB52 SPINE PROTECTOR, BAR BAG, 8L BAR DRYBAG, HELMET HOLDER, H2O BLADDER

PARAMETERS:

45 x 23 x 14 cm
650 g

MATERIALS:

NYLON 6.6, NYLON ROBIC, RIPSTOP, YKK ZIPPERS, NIFCO BUCKLES

BE LIGHTER AND FASTER. TAKE JUST TOOLS, BLADDER AND PROTECTOR, ALL NECESSARY EQUIPMENT FOR YOUR MAXIMUM TRAIL PERFORMANCE. WE INTRODUCE YOU EDGE OF A RAZOR BLADE.



TOOLS ORGANISER



RAINCOVER POCKET WITH EMERGENCY PRINT



HELMET HOLDER COMPATIBLE



SPLITTED SHOULDER STRAPS

LOW CENTER OF GRAVITY DESIGN WITH ADJUSTABLE LCG BAR



STRAPS CAN BE EASILY HIDDEN INSIDE



BAR BAG AND 8L BAR DRYBAG COMPATIBLE



POSITIONABLE LCG BAR

POSITIONABLE STERNUM STRAP WITH EMERGENCY WHISTLE

E3D VENTED BACK PANEL



GREY
ART NO. 203227



BLACK
ART NO. 203203

FEATURES:

- RAINCOVER INCLUDED
- HIDE STRAP SYSTEM
- TOOLS ORGANISER
- CLIP ON KEYCHAIN
- E3D VENTED BACKPANEL - KEEPS CENTER OF MASS CLOSE TO BODY
- REFLECTIVE DETAILS FOR HIGHER SAFETY
- FLASHLIGHT LOOP
- HIPBELT POCKETS
- COMPATIBILITY: BAR BAG, 8L BAR DRYBAG, H2O BLADDER

PARAMETERS:

21 x 30 x 11 cm
460 g

THIS ROOMY FANNY PACK WILL CARRY ALL STUFF NECESSARY FOR THE WHOLE DAY OF ADVENTURES. DO YOU NEED TO CARRY MORE? JUST USE BOTTOM „CARRY MORE STRAPS“.

MATERIALS:

NYLON 6.6, NYLON ROBIC, RIPSTOP, YKK ZIPPERS, NIFCO BUCKLES



BAR BAG AND 8L BAR DRYBAG COMPATIBLE



HIDE STRAP SYSTEM



TOOL ORGANISER



BIKE BOTTLE POCKET



PADDLED POCKET FOR TELEPHONE



POCKET WITH RAINCOVER, H2O BLADDER HOSE OUTLET



RAINCOVER INCLUDED



CLIP ON KEYCHAIN



HIPBELT POCKETS



COMPRESSION STRAPS



E3D BACK SYSTEM

ONYX 2



BLACK
ART NO. 203104

FEATURES:

- TOOLS ORGANISER
- CLIP ON KEYCHAIN
- E3D VENTED BACKPANEL - KEEPS CENTER OF MASS CLOSE TO BODY
- H2O BLADDER COMPATIBLE
- REFLECTIVE DETAILS FOR HIGHER SAFETY
- FLASHLIGHT LOOP
- ROOMY STRETCH POCKETS

PARAMETERS:

20 X 23 X 4 CM
210 G

MATERIALS:

NYLON 6.6, NYLON ROVIC, RIPSTOP, YKK ZIPPERS, NIFCO BUCKLES



GREY
ART NO. 203128

THIS GEMSTONE WILL ACCOMPANY YOU ON EVERY RIDE WITHOUT YOU EVEN NOTICING. TO BE WORN UNDER OR OVER THE JERSEY.



E3D VENTED BACK SYSTEM



TOOLS ORGANISER



H2O BLADDER COMPATIBLE, H2O BLADDER HOSE OUTLET



E3D VENTER BACK SYSTEM

BATTERY CASE



BLACK
ART NO. 502009

FEATURES:

- RAINCOVER INCLUDED
- HIDE STRAP SYSTEM
- TOOLS ORGANISER
- CLIP ON KEYCHAIN
- E3D VENTED BACKPANEL - KEEPS CENTER OF MASS CLOSE TO BODY
- REFLECTIVE DETAILS FOR HIGHER SAFETY
- FLASHLIGHT LOOP
- HIPBELT POCKETS
- EDGE 7, FLITE 10, 15, 20 AND ZAM 15 COMPATIBLE

PARAMETERS:

40 x 18 x 11 cm
210 g

PADDED BATTERY CASE FOR E-PERFORMANCE AND EXPERIENCE EXTENSION.

MATERIALS:

NYLON 6.6, RIPSTOP, NIFCO BUCKLES



THANKS TO THE VELCRO LOOPS THE CASE HOLDS IN PLACE AND WON'T DAMAGE ANYTHING

VELCRO STRAPS TO ATTACH CHARGER AND CABLES

VELCRO CLOSURE, SLIDE STRAP FOR EASY PULLING OUT

BIKE TRANSPORT BAG



BLACK
ART NO. 506007

FEATURES:

- YOU CAN PACK YOUR BIKE INSIDE AND PUT IT IN THE CAR
- NAMETAG
- SUPER LIGHTWEIGHT - NO REINFORCES

PARAMETERS:

80 X 130 X 30 CM
4500 G

LIGHTWEIGHT PADDED BAG FOR SAFE TRANSPORT AND ORGANISATION OF YOUR BIKE AND GEAR BY CAR OR PLANE.

MATERIALS:

NYLON 6.6, RIPSTOP, YKK ZIPPERS, NIFCO BUCKLES



FOUR HANDLES FOR COMFORTABLE CARRY AS A BIKE BOX AND PAIR OF SHOULDER STRAPS



TWO ZIPPER RIDERS ABLE TO LOCK TOGETHER



YKK ZIPPER WITH TWO RIDERS

WATERPROOF INSIDE WALLS, PADDED HANDLEBAR CASE

GROUND SHEET



BLACK
ART NO. 505000

FEATURES:

- PACKS ALL YOUR DIRTY STUFF IN THE WATERPROOF BAG
- NAMETAG - YOU'LL ALWAYS KNOW WHO SMELLS THE WORST
- ALSO USABLE AS A DIRTBAG WHEN BUILDING THE TRAILS

PARAMETERS:

16 x 15 x 9 cm
ø 130 cm
190 g

DIRTY CLOTHES CARRY BAG. JUST STEP IN, UNDRESS AND CLOSE THAT SMELLY STUFF INTO BAG BY PULLING THE HANDLES.

MATERIALS:

POLYESTER, PU COATING



PULL TWO STRINGS WITH BRAKES AND LEAVE ALL YOUR DIRTY STUFF INSIDE



YOU WON'T MIX YOUR STUFF WITH YOUR FRIENDS THANKS TO THE NAMETAG



COMPACT PACKAGE WITH NAMETAG POCKET

HELMET HOLDER



BLACK
ART NO. 504003

FEATURES:

- HOLD YOUR HELMET IN A PLACE
- COMPATIBLE WITH ALL THE ACEPAC BACKPACKS

PARAMETERS:

14 x 11 x 6 cm
21 x 21 cm
40 g

MESH HELMET HOLDER WITH LENGTH ADJUSTABLE FIXING STRAPS.

MATERIALS:

NYLON 6.6, RIPSTOP, YKK ZIPPERS,
NIFCO BUCKLES



COMPACT PACKAGE



EDGE 7



FLITE 6



ZAM 15 EXP



FLITE 15



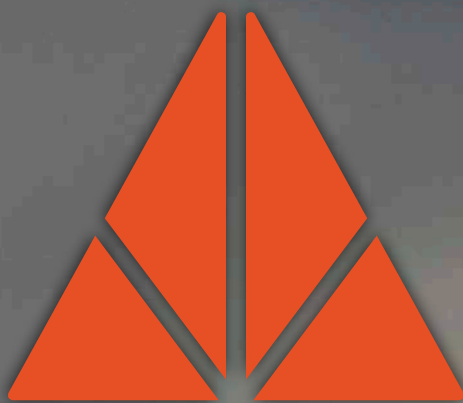

GRANITE

MULTI-TOOL & ACCESSORI



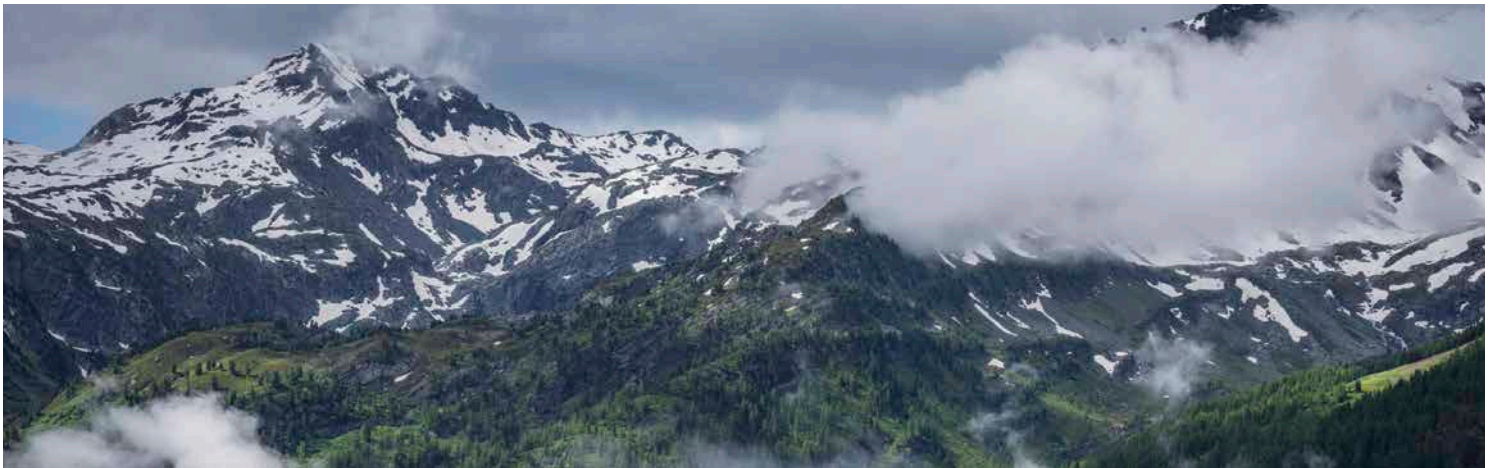

STASH SYSTEM

Stash takes all of those moments when we've been left fumbling in backpacks or cursing our luck at leaving a multi-tool on the workbench.

No more "where's my damn tool?" moments, no more bags-off at the trailhead delays and no more rides cut short by needless mechanicals.

Stash places a lightweight, multi-functional multi-tool right where you need it and firmly attached to your bike so it'll never be left behind. It stashes almost everything you'll ever need inside your steerer tube, ready to grab at a second's notice.

Compatible with alloy and carbon steerers and with versions of on and off-road, Stash means you'll never be left stranded and you'll never have to hold up your ride to find your tools.

Simply grab, adjust, stash and go.



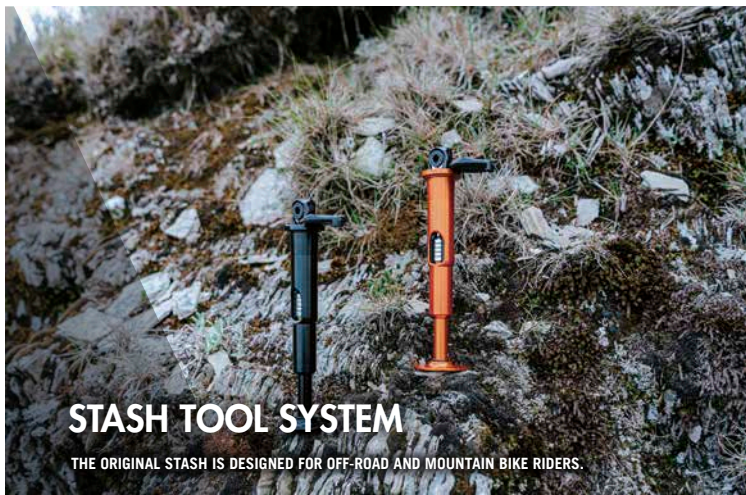

STASH TOOL SYSTEM

THE ORIGINAL STASH IS DESIGNED FOR OFF-ROAD AND MOUNTAIN BIKE RIDERS.

STASH hides a small arsenal of tools elegantly in your steerer tube. They can be grabbed and deployed within seconds with no hold-ups on your ride and no need to rummage around in a bulky backpack.

Hidden away inside STASH has a mighty 9-piece multi-tool. With 2, 2.5, 3, 4, 5, 6, and 8mm Allen keys, a T25, and a PH1.

You should have everything to fix all but the worst of mechanical mishaps.

At just 159g the system is super light and won't do anything to upset the feel of your ride. Unlike the competition, it can be fitted quickly and easily with no tapping of your steerer required.

STASH RT RATCHET TOOL KIT is compatible with alloy steerer tubes.



STASH RT RATCHET TOOL KIT

Light weight storage for essential tools, hidden away in your steerer tube.

The tool kit includes a ratchet wrench and 9 tool bits. The extended Ph1 bit can be used as a leverage arm. Weighs a mere 159g.

Installation is quick and easy with no tapping of your steerer required.

- 9-piece 2 / 2.5 / 3 / 4 / 5 / 6 / 8 / T25 / PH1
- System weight (incl. multi-tool) 159g
- Color Black / Orange



Ratchet Socket Set

- Fits tapered steerer tube with the "bottom of fork crown to top of stem" length from 150mm to 250mm".

- A cycling computer mount top cap is available for Garmin, Bryton and Wahoo devices (Sold separately).

STASH CHAIN REPAIR TOOL KIT

The STASH Chain Tool hides in your handlebar, ready to deploy at a moment's notice.

It's beautifully machined from AL7075 and contains a tough and light weight chain tool with room for a quick-link.

STASH works with 9 to 12 speed chains and open-end and lock-on grips.

- Dimension 30 x 30 x 96mm (large cap) / 21.8 x 21.8 x 96mm (small cap)
- Fitting Open-end grip or lock-on grip with 18 to 21mm orifice and 10cm straight section at the bar end.
- Weight 50g (incl. side cap)
- Color Black / Orange

Note: Chain Quick-link is not included.

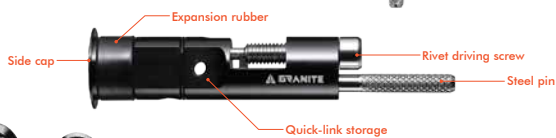

30mm side cap 22mm side cap

STASH TYRE REPAIR TOOL KIT

A puncture should never blow up your bike ride.

STASH Tyre Plug Kit is an all-in-one kit design. It's got all the tools you need to avert disaster-ready for action at any time. It includes a tyre reamer, tyre fork, and 4 plugs to quickly seal tubeless punctures.

- Dimension 30 x 30 x 96mm (large cap) / 21.8 x 21.8 x 96mm (small cap)
- Fitting Open-end grip or lock-on grip with 18 to 21mm orifice and 10cm straight section at the bar end
- Weight 35g (incl. side cap)
- Color Black / Orange

- Each set comes with 2 x 1.5mm and 2 x 3.5mm tyre plugs.



22mm side cap 30mm side cap



STASH TOOL KIT AirTag MOUNT

The integrated AirTag capsule is the perfect way to keep your AirTag safe and sound, while also keeping it hidden from view on your suspension fork.

This capsule is designed to fit snugly at the bottom of your suspension fork with the Granite Stash and the all new Stash RT. It features a durable construction with a CNC'd alloy base as the lower cap of the Stash system and a composite cap to avoid AirTag's RF signal from being blocked. It only comes in black as the perfect way to stealthily keep your AirTag hidden and protected.

- Dimension 30 x 30 x 96mm
- Fitting Stash and Stash RT with 42mm lower cap.
- Weight 50g (incl. side cap)
- Color Black alloy lower cap / Matt black plastic cap

Note: Apple AirTag is not included.



STASH Multi-Tool Kit



STASH RT Ratchet Tool Kit



SCOPE MOUNT FOR STASH RT

Scope converts your Granite Stash RT ratchet tool kit to add a quick-release mount for your onboard computer.

It's compatible with Garmin, Wahoo and Bryton devices.

- Dimension Outside diameter - 34mm / Thick - 10mm
- Weight 15g
- Color Black

Note: This mount is only for Granite Stash RT ratchet tool kit.



PLASTIC MOUNT FOR BRYTON

SCOPE MOUNT OPTIONS

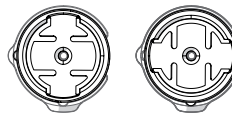

Garmin

Wahoo



Bryton



STASH RCX MULTI-TOOL KIT

THE GRANITE DESIGN STASH RCX MULTI-TOOL IS A 2021 DESIGN & INNOVATION AWARD WINNER.

STASH RCX TOOL SYSTEM, designed specifically for road and gravel bikes.

Stash hides a tiny but mighty multi-tool neatly in the steerer tube of your drop-bar bike, accessible from the top cap of your stem. It can be grabbed, used and returned in seconds without interrupting the flow of your ride.

At just 110g for the complete system, the Granite RCX is super lightweight and won't do anything to hold you back or interrupt the clean lines of your ride.

The RCX can be fitted quickly and easily without specialist tools or any tapping of your steerer tube. Simply remove the star-nut from your fork and replace it with the RCX's innovative compression plug using a 5mm hex key. Once installed, the plug provides a simple and secure mounting point for the RCX tool.

STASH RCX MULTI-TOOL KIT is compatible with alloy and carbon steerer tubes.



STASH RCX MULTI-TOOL KIT

Super light weight storage for essential tools, hidden away in your steerer tube.

The STASH system hides a lightweight and super useful multi-tool, valve core remover and spoke key inside your steerer tube. With 2, 2.5, 3, 4, 5, 6mm hex keys, a T25, a flathead screwdriver, 4 spoke key options and a valve core remover you should have everything you need to perform all of your road or trail side repairs.

- 8-piece Multi-tool 2 / 2.5 / 3 / 4 / 5 / 6 / T25 / Flathead
- Spoke key 0 / 1 / 2 / 3 with valve core removing function
- System weight 110g
- Multi-Tool weight 57g
- Color Black / Orange

Warning:

- May not work with Rockshox Forks and Fox Forks steerer due to the steerer internal tapered construction.



Multi tool



Spoke key



- Stash RCX fits forks with or without the open end at the bottom of steerer tube.

- The inner diameter of the fork steerer needs be round shape and measured between 23.5mm to 27mm.

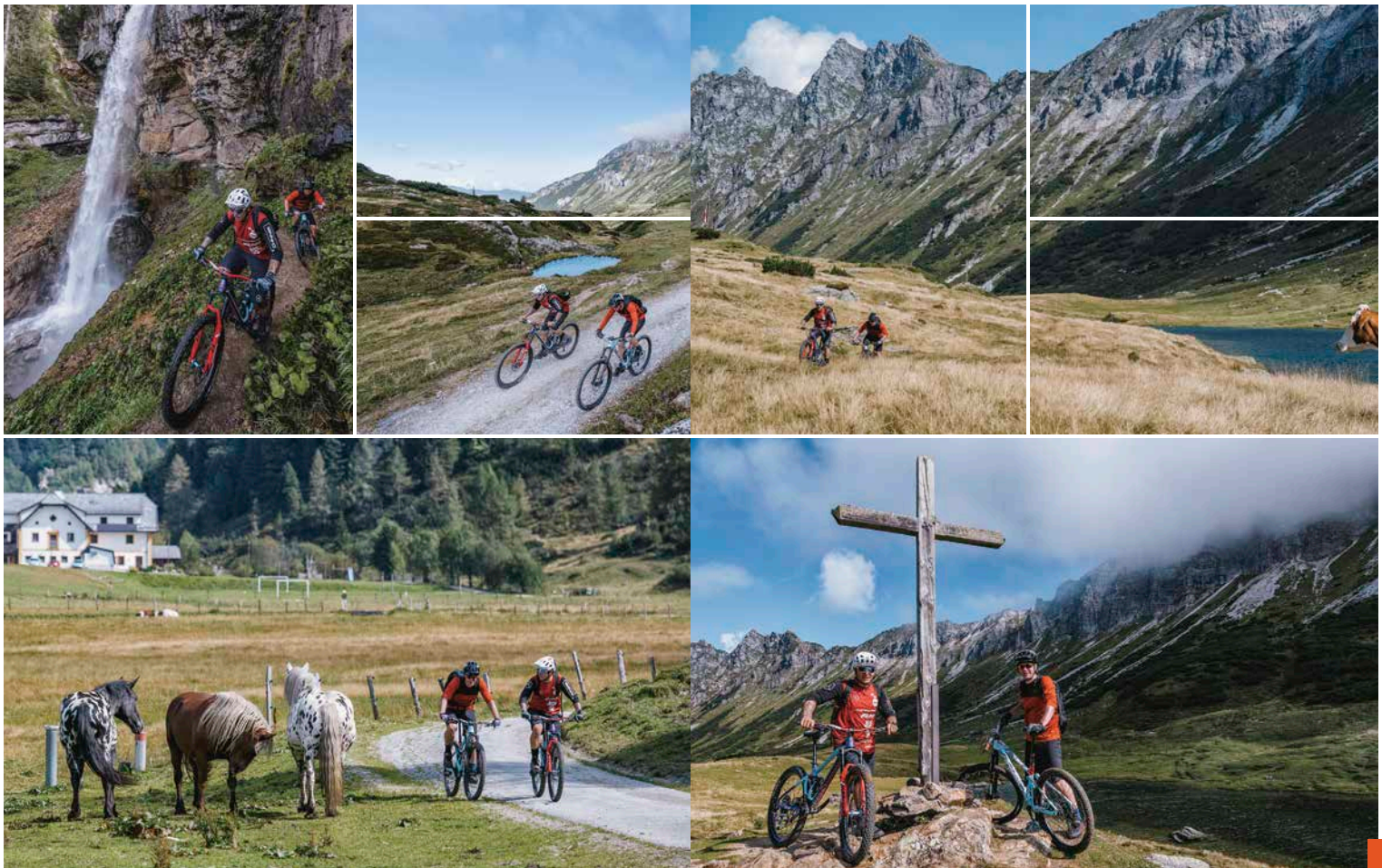

STRAP SOLUTION

The Granite Design Strap collection upgrades your bike with added storage.

Simple to use, rock-solid and quick-to-access our strap systems attach those must-have essentials to your frame. They add extra storage to your bike and eliminate the need for bulky backpacks or over-full fanny packs.

They're the answer to riders that don't have bottle bosses on their frames, hate backpacks or simply need to carry some extra gear.

By fixing tubes, pumps, tools, snacks (and whatever else you need!) to your frame you'll never be left without and never be slowed down by rummaging in packs to find what you need.





QUIVER TOOL ROLL

QUIVER KEEPS YOUR EXTRA KIT WITHIN REACH AND ALLOWS YOU TO SWAP IT BETWEEN BIKES.

The Quiver will look after your extra tools, a spare tube, and even spare change or a credit card for a long day ride. It's quick and easy to attach and release, giving rapid access to your stuff, and allowing you to swap it between bikes, making it the most versatile bike storage solution around.



QUIVER TOOL ROLL

The Quiver is a simple roll-up tool bag that allows you to carry any extra kit you need safely and securely. The evolution of the humble saddle bag, the Quiver will look after your extra tools, a spare tube*, and even spare change or a credit card for a long day ride.

Designed for road tubes and lightweight mountain bike tubes eg. Tubolito, Schwalbe Aerothan and Pirelli PZero.

- Dimension 28 x 23mm / W x H
- Weight 1.5g
- Color Black

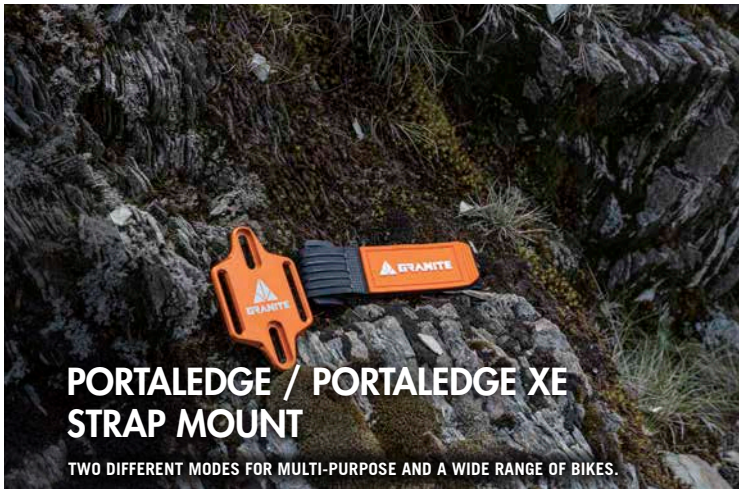

PORTALEIDGE / PORTALEIDGE XE STRAP MOUNT

TWO DIFFERENT MODES FOR MULTI-PURPOSE AND A WIDE RANGE OF BIKES.

Portaledge turns your unused bottle-bosses into a lightweight, rock-solid, and kind-on-paint stash for your essentials. With room for a tube, CO2 and tyre levers it guarantees you'll never be left stranded on the trails.

Making use of your standard bottle-bosses, Portaledge weighs just 40g and is made up of a tough AL6061 alloy plate with 30mm silicone-coated hook and loop strap. Simply bolt the plate in place and use the strap to quickly and easily stash your must-have essentials on your frame. The design is quick to install, easy to use and will lock your gear in place through the roughest trails and toughest conditions.



PORTALEIDGE STRAP MOUNT

Portaledge makes use of your standard bottle-bosses and mounts alongside your water bottle cage.

It is made up of a tough AL6061 alloy plate with 30mm silicone-coated hook and loop strap. Simply bolt the plate in place and use the strap to quickly and easily stash your must-have essentials on your frame. The design is quick to install, easy to use, and will lock your gear in place through the roughest trails and toughest conditions.

- Dimension 52 x 83mm / W x H (Alloy plate)
30 x 330mm / W x L (Silicone-coated hook and loop strap)
- Weight 35g
- Color Orange / Black



PORTALEIDGE XE STRAP MOUNT

Portaledge XE of your standard bottle-bosses and mounts alongside your water bottle cage.

It is made up of a tough AL6061 alloy plate with 30mm silicone-coated hook and loop strap. Simply bolt the plate in place and use the strap to quickly and easily stash your must-have essentials on your frame. The design is quick to install, easy to use, and will lock your gear in place through the roughest trails and toughest conditions.

- Dimension 54 x 186mm / W x H (Alloy plate)
30 x 330mm / W x L (Silicone-coated hook and loop strap)
- Weight 50g
- Color Orange / Black





AUX BOTTLE CAGE STRAP KIT

THE AUX BOTTLE CAGE IS THE ANSWER TO YOUR "WHY CAN'T I FIT A BOTTLE CAGE ON MY BIKE?!" PRAYERS.

Whether you're looking to carry an extra bottle or your bike simply doesn't have bosses, AUX will strap a top-quality, safe and secure side-loading cage to your frame so you'll never go thirsty again.

The AUX kit includes a lightweight, side-loading cage that's designed to work with tight-fit frames and is made from super-tough carbon-fiber-reinforced thermoplastics with a stealthy matt finish.

The AUX Strap Kit, which includes everything you need to attach the cage to almost any bike frame in almost any location. The Kit uses silicone-coated hook-and-loop straps and grippy rubber pads for a rock-solid fit that won't leave your bottle on the trails.

Whether you're adding a water-bottle to your full suspension MTB or your stove fuel on your adventure bike, Aux has you covered.



AUX STRAP KIT SERIES

No room for a bottle? No problem!

The Granite Aux Bottle Cage with strap kit is the answer to your "why can't I fit a bottle to my bike?!" woes.

Whether you're looking to carry an extra bottle or your bike simply doesn't have bosses, AUX will straps lightweight, safe and secure side-loading cage to your frame or fork so you'll never go thirsty again.

The Aux Strap Kit includes everything you need to attach the cage to almost any bike frame in almost any location. The Kit uses silicone-coated hook-and-loop straps and grippy rubber pads for a rock-solid fit that won't leave your bottle on the trails.

- Dimension 81.5 x 78.5 x 145mm (Carbon bottle cage)
- Straps 2 options (Aux Strap Kit / Aux E+ Strap Kit)
Aux Strap Kit (Fits frames from 27.2mm to 70mm.)
Aux E+ Strap Kit (Fits frames from 70mm to 130mm.)
- Weight 50g
- Color Black

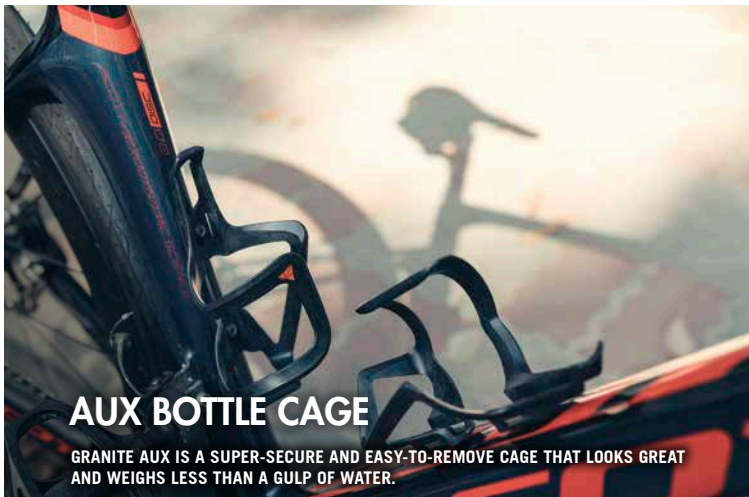

AUX BOTTLE CAGE

GRANITE AUX IS A SUPER-SECURE AND EASY-TO-REMOVE CAGE THAT LOOKS GREAT AND WEIGHS LESS THAN A GULP OF WATER.

The Aux Bottle Cage is a lightweight, super-neat and easy-to-use side loading bottle cage for on and off-road bikes.

Compatible with the Aux strap kit but also with traditional bottle bosses, the cage will fit bikes of all shapes and sizes. It is built to be compact so that it will work with full suspension frames that are tight on space.

Weighing just 23g, the Aux cage is one of the lightest bottle cages around.



AUX BOTTLE CAGE

The AUX bottle cage is a lightweight, side-loading cage that makes Aux easy to use and ideal for compact frames with limited space.

Super tough carbon fiber, reinforced with thermoplastics keeps weight low and strength up.

- Dimension 81.5 x 78.5 x 145mm (Carbon Bottle cage)
- Weight 23g
- Color Black



ROCKBAND+

Ditch the bag. Rock harder with ROCKBAND+.

A super light, super tough and super easy to use strap for carrying inner tubes and tools on your frame. The secondary inner-strap guarantees your essentials always stayed locked in place when you're rocking hard.

Rockband+ adds an extra 40mm over the classic Rockband for increased carrying capacity. It is built with a tough Tetoron fabric and a range of eye-catching designs.

- Dimension Length - 490 mm / Width - 32 mm
- Weight 25g



ROCKBAND

Ditch the backpack, rock on with ROCKBAND.

The original Granite strap solutions, the ROCKBAND is a super light, super tough and super easy to use strap for carrying inner tubes and tools on your bike frame.

The secondary inner-strap guarantees your essentials always stay locked in place when you're rocking hard.

Rockband is built with a tough and durable polypropylene fabric with a protective grip patch.

- Dimension Length - 450 mm / Width - 32 mm
- Weight 23g
- Color Black, Red, Pink, Blue, Orange, Yellow, Purple, Green, Turquoise Blue, Camo Green, Brown



ROCKnROLL

ROCKnROLL is a precision-built and lightweight multitool kit for road, gravel, and mountain bikes.

ROCKnROLL is made with special abrasion resistance and high strength CORDURA fabric. A special loop strap with protective patch at the back of roll is designed to work with GRANITE ROCKBAND carrier strap. The 9 handy attachments ensure that it'll be your go-to for all of your home or trailside repairs and the tough, compact carry case means you'll never ride without it.

Additional two pockets for your spare chain Quick Link.

- Dimension 130 x 50 x 30mm (L x W x H)
- Features Includes 9 Hex bits (2mm/2.5mm/3mm / 4mm/5mm/6mm/8mm), Star bit (T25), and Philips bit (PH2) in the kit.
- Weight 130g
- Color Black / Camo green

Note: Chain Quick-link is not included.

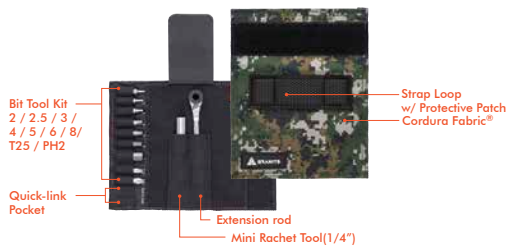

PUNK CO2 INFLATOR

Never mind the punctures, here's the new Granite Punk CO2 inflator!

The Punk CO2 Inflator is a tiny but mighty stashable tool that'll ensure you're never left stranded on the trails. It works perfectly with MTB carrier straps and allows easy inflation of tyres.

When anarchy strikes and your tyres go flat, just grab the Punk and you'll be kicking out the jams again on the trails in no time.

- Dimension Small / Large (For 16g and 25g CO2 canister, respectively)
- Weight Small - 16g / Large - 25g
- Color Black



ADD-ONS

Our Add-Ons are the end-result of endless experiences and adventures on two wheels around the world.

They are born out of countless 'we need a solution for that!' moments where the trail has thrown a problem in our way and we've looked for an innovative, great value answer.

Hard to define but endlessly useful, our Add-On collection contains those perfect products that you'll forget you own but use every time you ride a bike.

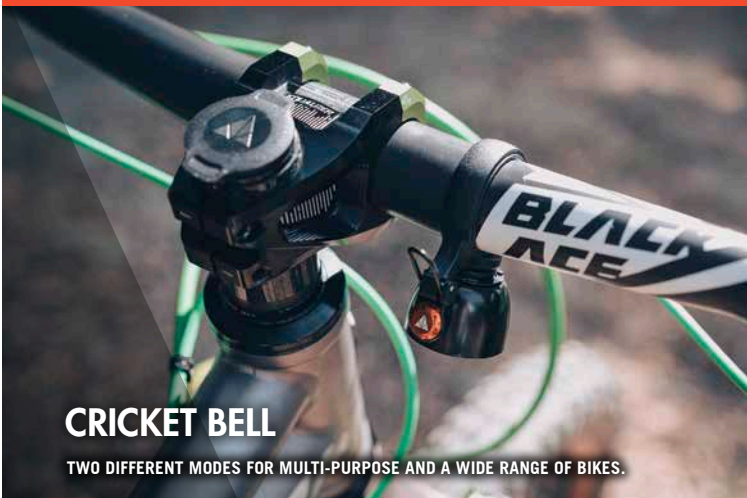

CRICKET BELL

TWO DIFFERENT MODES FOR MULTI-PURPOSE AND A WIDE RANGE OF BIKES.

The Cricket is a tiny but mighty bike bell that'll guarantee you're heard before you're seen.

Sitting neatly on any handlebar, the Cricket will keep you safe on the streets or on the trails without weighing you down or ruining the clean lines of your bike.

Featuring two modes, the Cricket can be struck for a single, sharp 'ding!' or switched to let out a constant ding-ding-ding. Like the creature that inspired its name, the Cricket is tiny but always in your ear. You'll hear it long before you see it.



SINGLE-STRIKE MODE



COWBELL MODE



CRICKET BELL

The Cricket Bell features two modes, single-strike and cowbell.

In single-strike, it'll ring out loud with a crystal-clear sound that'll guarantee to make your presence known.

Set it to Cowbell and it'll provide a constant, gentle tone that's perfect for anywhere that needs a little more attention.

- Dimension 34.5 x 67.5 mm (single-strike mode) / 34.5 x 73.5 mm (cowbell mode)
- Weight 60g
- Color Black



SPACER FITTING OPTIONS

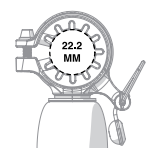
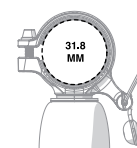
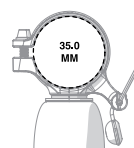

- Supplied with spacers to fit 22.2mm to 35mm handlebars.



TALON TYRE LEVERS

TALON ENSURES YOU'LL NEVER BE LEFT STRANDED. QUICKLY REMOVE TYRES OR FIX BROKEN CHAINS AND GET BACK TO DOING WHAT YOU LOVE.

The Talon's two pieces clip together to form a neat tool for breaking and fixing quick-links on chains.

It pairs super-strong fibre-reinforced nylon levers and stainless-steel tips. There's also room to store a spare quick-link so you're never left in a jam.

The tool works with 9 to 12-speed quick-links and chains.



TALON TYRE LEVERS

The Talon is ready to swoop in and fix punctures and broken chains.

Clip it together and you've got a quick-link tool for breaking and fixing chains. Unclipped, the Talon acts as two light-but-tough tyre levers.

Talon pairs strong nylon levers and stainless-steel tips to guarantee it will go the distance but won't damage your gear. There's even space for a spare quick-link.

- Dimension 8 (H) x 19 (W) x 130 (L) mm / 2pc
- Weight 40g / 2pcs
- Color Black, Orange



SCOPE MOUNT FOR SWAT

Scope converts your SWAT Conceal Carry tool to add a quick-release mount for your onboard computer.

It's compatible with Garmin, Wahoo and Bryton devices.

- Dimension Outside diameter - 35mm / Thick - 10mm
- Weight 15g
- Color Black

- This mount is only for Specialized bikes with SWAT conceal carry tool kit.

SCOPE MOUNT OPTIONS

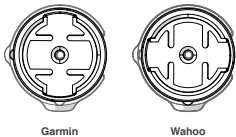

Garmin

Wahoo



Bryton



PLASTIC MOUNT FOR BRYTON

PITA PEDAL COVERS

Pita Pedal Covers protect your bike, and other bikes around it, against damage when in storage and transit.

If you've ever scratched a mate's paint with your pedal or bent a spoke in the van you'll know exactly why you can't live without a Pita.

- Dimension Small - 115 (L) x 105 (W) mm
Large - 125 (L) x 135 (W) mm
- Weight Small - 54g (Pair) / Large - 76g (Pair)
- Color Black, Green Camo



SMALL

LARGE



JUICY NIPPLE

Funny name... Seriously useful valve!

Our tubeless valve with a handy cap that doubles as a valve core remover. Simply remove the cap, flip it sideways and you can remove your valve core for easy inflation and sealant top ups.

And, of course, it comes in a whole range of colours to match or clash with your style.

- Weight 2.5g (Caps in pair)
11.2g (Caps with 45mm valves in pair)
12.4g (Caps with 60mm valves in pair)
13.6g (Caps with 80mm valves in pair)
- Valves Color Black
- Cap Color Red, Orange, Gold, Pink, Green,
Purple, Blue, Black, Oil Slick



The Talon's two pieces clip together to form a neat tool for breaking and fixing quick-links on chains.

It pairs super-strong fibre-reinforced nylon levers and stainless-steel tips. There's also room to store a spare quick-link so you're never left in a jam.

The tool works with 9 to 12-speed quick-links and chains.



PRESTA VALVE CORE PACK

Granite Presta valve core pack includes 10 high-quality valve cores that are designed to fit Presta valve stems, as well as a convenient installation tool. The valve cores are made from durable materials and are perfect for replacing any that have become clogged with tire sealant.

- Dimension 52 x 83mm / W x H (Alloy plate)
- Weight 35g
- Color Orange / Black



PRESTA VALVE STEM EXTENDERS

Granite valve stem extenders allow you to extend the length of your Presta valve stems by 40mm, making it easier to reach and inflate your bike tires.

Sold in pairs, the extenders are compatible with standard Presta valves. Whether you have deep-section wheels or just want a little extra reach, this valve stem extender is an easy and convenient way to ensure proper tire inflation.

- Dimension 54 x 186mm / W x H (Alloy plate)
- Weight 50g
- Color Black





A full-page photograph of a mountain biker in a black jersey and helmet, riding a blue and black trail bike on a rocky, grassy path. The biker is wearing a black helmet with a clear visor, black gloves, and black shorts with a white 'R' logo. The bike has 'ROCK' and 'FATBARK' branding. The background is a clear blue sky and green foliage.

RACER

FRANCE | 1927

PROTEZIONI • GUANTI • ACCESSORI

DORSALES & GILETS ADULTES

ADULTS BACK PROTECTORS

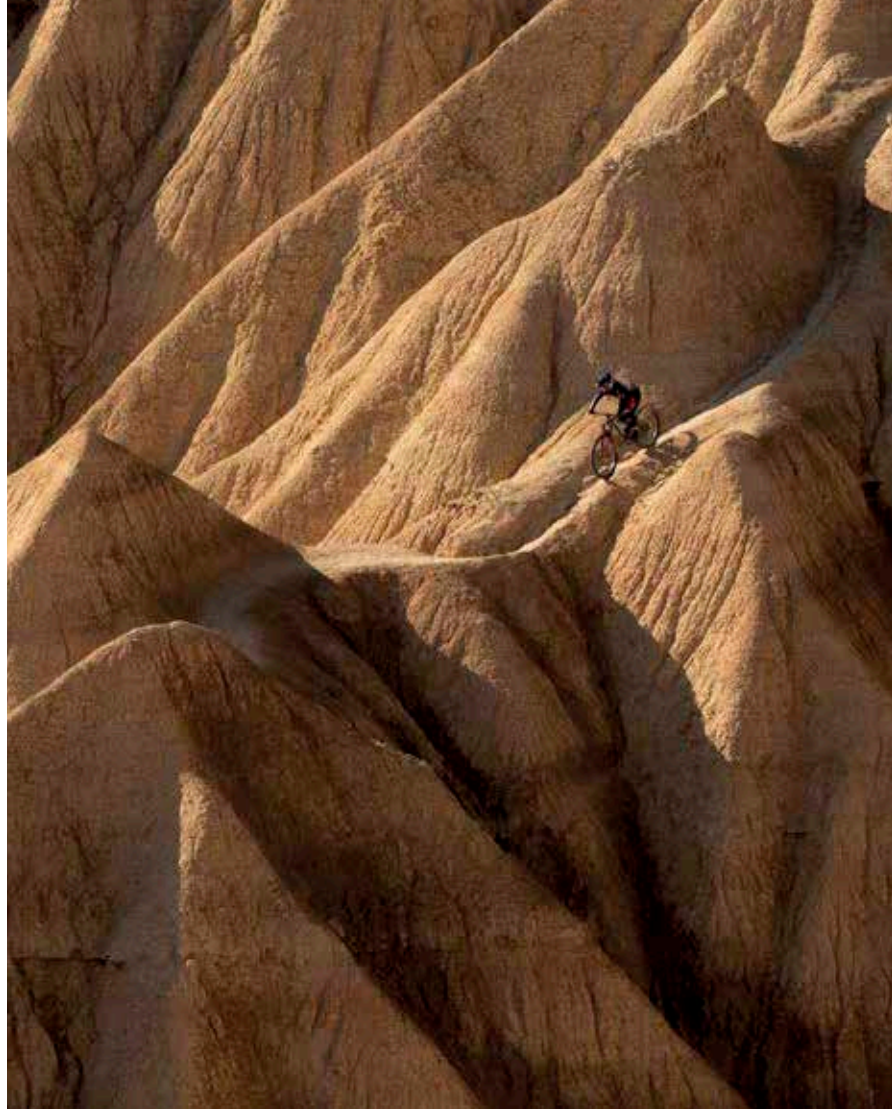

ALPHA PLASTRON

S - M - L



ALPHA PLASTRON est le chef de file de la gamme ALPHA qui signe le renouvellement des produits RACER vélo. Ultra léger et très respirant grâce à son nouveau mesh fin et résistant, ce plastron intègre les dernières innovations D3O® pour toujours plus de légèreté sans compromis sur la protection de son utilisateur.

C'est un produit 2 en 1 : il peut être utilisé avec le duo protection pectorale et protection dorsale ou simplement avec cette dernière. Un jeu de sangles pour l'utilisation en dorsale seule est vendu avec l'ensemble ALPHA PLASTRON.

Pour toujours plus de praticité, ce plastron intègre une poche de rangement à l'arrière.

Impossible de ne pas être séduit par le look sobre et futuriste de ce produit, ainsi que son extrême légèreté. Il est homologué CE niveau 1.



/EN

ALPHA PLASTRON is the flagship product of the ALPHA range, which signs the renewal of the RACER bike products. Ultra-lightweight, highly breathable, this chest protector features a brand-new, thin, and resistant mesh fabrics. It integrates the latest D3O® innovations, lighter than ever without compromising the protection of its user. It is a 2 in 1 product: it can be used with the chest and back protector duo or simply with the back protector. A set of straps for the single back-protector use come with the ALPHA PLASTRON set. For even more convenience, this chest protector has a back storage pocket. The extreme lightness paired with its understated and futuristic look will seduce the most demanding riders. It is CE level 1 certified.

/IT

ALPHA PLASTRON è il modello di punta della gamma ALPHA che segna il rinnovamento degli articoli RACER per ciclisti. Ultraleggera e molto traspirante grazie al nuovo tessuto mesh fine e resistente, questa pettorina integra le ultime innovazioni D3O® per una leggerezza sempre maggiore e senza compromessi sulla protezione del suo utilizzatore. È un prodotto 2 in 1: può essere utilizzata con l'abbinamento di protezione pectorale e protezione dorsale oppure solo con quest'ultima. Con il set ALPHA PLASTRON è in vendita anche un corredo di cinghie da utilizzare come solo paraschiene. Per maggiore praticità, la pettorina incorpora una tasca portageggi sul retro. Impossibile non rimanere affascinati dal look sobrio e futuristico di questo articolo, oltre che dalla sua estrema leggerezza. Omologato CE livello 1.

OUTSHELL

LIGHT MESH,
LYCRA

PROTECTION

D3O®

WEIGHT

750 GRS

MOTION TOP 2

S - M - L - XL

D30®



Le MOTION TOP 2 est plus léger et plus respirant grâce à l'utilisation de trois nouveaux mesh. Il incorpore les dernières innovations D30® pour plus de légèreté et de protection. Un pad en mousse EVA perforé de 5mm recouvre la poitrine et les côtes. Une poche de rangement a été ajoutée pour passer au nombre de trois ainsi que des élastiques de renfort au niveau des coudes et de la dorsale pour un meilleur maintien. Cette nouvelle version conserve ses atouts comme le zip intégral YKK®, sa compatibilité poche à eau, les manches amovibles, et un traitement anti-odeur et antibactérien ATR®. Le MOTION TOP 2 est une véritable référence sur le marché. Il est homologué CE niveau 1.

/EN

The MOTION TOP 2 incorporates the latest D30® innovations for greater lightness and protection. A 5mm perforated EVA foam pad covers chest and ribs. This new version keeps its attractive features such as the YKK® full zip, water bladder compatibility, the removable sleeves, and an anti-odor and antibacterial ATR® treatment. The MOTION TOP 2 is the leading top of the market. It is CE level 1 homologated.

/IT

Il MOTION TOP 2 integra le ultime innovazioni D30® per una maggiore leggerezza e protezione. Un'imbottitura in EVA foam perforata da 5 mm ricopre il torace e le costole. Mantiene i suoi punti di forza come la cerniera integrale YKK®, la compatibilità con la sacca per l'acqua, le maniche rimovibili e un trattamento ATR® anti-odore e antibatterico.

OUTSHELL

MESH, LYCRA

PROTECTION

D30®

WEIGHT

990 GRS



MOTION TOP WOMEN

S - M - L

D30®



Le MOTION TOP WOMEN garde la légèreté de la version homme et sa technicité. Très respirant grâce à l'utilisation du nouveau mesh très fin et résistant, ce produit très technique s'adapte à toutes les morphologies féminines. Il incorpore non seulement les mêmes innovations D30® que MOTION TOP 2, mais possède en plus une protection pectorale très performante. Des pads en EVA de chaque côté viennent compléter cette protection. 3 poches de rangement ont été incorporées, ainsi que des élastiques de renfort au niveau de la protection pectorale et dorsale pour un meilleur maintien. Cette nouvelle version dédiée aux femmes conserve ses atouts de MOTION TOP 2 comme le zip intégral YKK®, sa compatibilité poche à eau, les manches amovibles, et un traitement anti-odeur et antibactérien ATR®. Ergonomique et looké, le MOTION TOP WOMEN est une référence sur le marché. Il est homologué CE niveau 1.

/EN

The MOTION TOP WOMEN keeps the technical sophistication and lightness of the men version. Highly breathable thanks to the use of the new thin and resistant mesh, this very technical product adapts to all female bodies and shapes. It incorporates not only the same D30® innovations as the MOTION TOP 2, but also features a high-performance chest protection. EVA pads on each side complete this protection. Three storage pockets have been incorporated, as well as reinforcing elastics in the chest and back protection for a better fit. This new woman dedicated version keeps the MOTION TOP 2 assets such as the YKK® full zip, water bag insert, the removable sleeves, and the anti-odor and antibacterial ATR® treatment. Ergonomic and stylish, the MOTION TOP WOMEN is the new reference on the market. It is CE level 1 approved.

/IT

Il MOTION TOP WOMEN conserva la stessa leggerezza e tecnicità della versione per uomo. Molto traspirante grazie all'utilizzo del nuovo tessuto mesh sottilissimo e resistente, questo articolo hi-tech si adatta a tutte le morfologie femminili. Non solo offre le stesse innovazioni D30® di MOTION TOP 2, ma è anche munito di una protezione pettorale dalle alte prestazioni. Dei pad in schiuma EVA bilaterali completano la protezione. Nell'articolo sono presenti 3 tasche portaoggetti, nonché elastici di rinforzo a livello della protezione pettorale e dorsale per un migliore supporto. Questa nuova versione dedicata alle donne conserva i punti di forza di MOTION TOP 2 come la zip integrale YKK®, la compatibilità con le sacche d'acqua, le maniche rimovibili e un trattamento anti-odore e antibatterico ATR®. Ergonomico e dal look straordinario, MOTION TOP WOMEN costituisce un punto di riferimento sul mercato. Omologato CE livello 1.

OUTSHELL

MESH, LYCRA

PROTECTION

D30®

WEIGHT

900 GRS



MOUNTAIN TOP 2

S - M - L - XL

SAS-TEC
body protection systems



Le MOUNTAIN TOP 2 est un gilet idéal pour le BMX et la descente. Il est composé de trois mesh très respirants et de lycra pour un maximum de confort et de respirabilité. Il intègre des pads de protections amovibles SAS-TEC® au niveau dorsal, sur les épaules et les coudes. Une mousse perforée EVA de 5mm prend place sur le thorax et les côtes tout en assurant une bonne ventilation. Pour faciliter son enfilage, un zip latéral et intégral YKK® a été conçu spécialement. Le gilet est compatible avec une poche à eau. Il est homologué CE niveau 1.

/EN

The MOUNTAIN TOP 2 is composed of three highly breathable meshes and lycra for maximum comfort and breathability. It includes removable SAS-TEC® protective pads on the back, shoulders and elbows. A 5mm perforated EVA foam is fitted to the thorax and ribs, ensuring good ventilation. A YKK® side and full zip has been specially designed to make it easier to put on.

/IT

Il MOUNTAIN TOP 2 è composto da tre mesh e lycra per il massimo comfort e traspirabilità. Incorpora cuscinetti protettivi SAS-TEC® rimovibili su schiena, spalle e gomiti. Su petto e costole, è posizionato uno strato di EVA foam perforata da 5 mm, che garantisce una buona ventilazione. Affinché sia più facile da indossare, è stata appositamente progettata una cerniera laterale integrale YKK®.

OUTSHELL
MESH, LYCRA

PROTECTION
SAS-TEC™

WEIGHT
800 GRS



PRO TOP 3

S - M - L - XL

D30®



Le PRO-TOP 3 est un gilet très léger, spécialement conçu pour l'enduro, composé de deux mesh techniques. Il intègre la dorsale D30® BP3 AERO pour une protection optimale et un niveau de confort exceptionnel. Conçu pour palier au sac à dos, il intègre 2 poches latérales zippées dont une waterproof ainsi que 3 poches types maillot cycliste dans le dos et une poche pour insérer votre poche à eau 3L. Enfin, il reçoit un traitement anti-odeur et antibactérien ATR®. Il est homologué CE niveau 1.

/EN

The PRO-TOP 3 is a light vest, made specially for enduro, composed with two technical mesh. You will benefit from the D30® BP3 AERO dorsal for your protection and comfort. Thought to replace your backpack, we added 2 zipped side pocket, one waterproof, 3 back pockets as well as a pocket to add your water system. Finally, it comes with anti-odor & antimicrobial ATR® treatment.

/IT

PRO-TOP 3 è un gilet leggero, realizzato appositamente per l'enduro, composto da due mesh tecniche. Potrai disporre del D30® BP3 AERO dorsale per la tua protezione e il tuo comfort. Pensato per sostituire lo zaino, abbiamo aggiunto 2 tasche laterali con zip, una impermeabile, 3 tasche posteriori e una tasca per aggiungere un sistema ad acqua. In-fine, è realizzato con trattamento ATR® antiodore e antimicrobico.

OUTSHELL
MESH, LYCRA

PROTECTION
D30®

WEIGHT
530 GRS



VIPER 2

M - L - XL

D30®



La VIPER 2 est une dorsale amovible constituée d'une enveloppe en mesh et néoprène afin de garantir un maximum de confort et de légèreté. Ses bretelles et sa ceinture sont réglables, ce qui rend cet accessoire ergonomique. Elle est dotée de la dorsale D30®. Elle est préconisée pour une utilisation en DH et dirt. La dorsale VIPER 2 est homologuée en EPI de deuxième catégorie niveau 2, soit le plus haut niveau de protection que peut offrir une dorsale.

/EN

The VIPER 2 is a removeable dorsal made with mesh and neoprene in order to offer you maximum comfort and lightness. Its shoulders straps and hip belt are adjustable for better ergonomic. It's equipped with D30® Viper II dorsal accredited PPE (EPI) second category (level 2), being the highest protection level for a dorsal. We recommend for a DH and Dirt usage.

/IT

VIPER 2 è un protettore dorsale rimovibile realizzato in mesh e neoprene per offrire il massimo del comfort e della leggerezza. Le spalline e la cintura sono regolabili per una migliore ergonomia. È dotato del sistema D30® Viper II livello 2, il livello di protezione più elevato per un protettore dorsale DPI. Se ne consiglia l'uso per DH e Dirt.

OUTSHELL
MESH, NEOPRENE

PROTECTION
D30®

WEIGHT
800 GRS



DORSALES & GILETS ENFANTS

KIDS BACK PROTECTORS



MOTION TOP KID 2

XXS / 6Y - XS / 8Y - S / 10Y

SAS-TEC
body protection systems
CE

Le gilet MOTION TOP KID 2 est la protection corporelle la plus aboutie et la plus confortable pour les enfants. Idéale pour le BMX ou le bikepark, cette nouvelle version intègre la technologie SAS-TEC™ au niveau de la dorsale, des épaules et des coudes. Une mousse perforée EVA de 5mm prend place sur le thorax et les côtes tout en assurant une bonne ventilation. Pour faciliter son enfilage, un zip latéral et intégral YKK® a été conçu spécialement et ce gilet est compatible avec une poche à eau. Il est homologué CE niveau 1.

/EN

The MOTION TOP KID 2 vest is the most accomplished and comfortable kid protection (from 6yo). Light and breathable thanks to the technical mesh, it integrates SAS-TEC® on back, shoulders and elbows as well as EVA perforated pad to protect thorax and rib. An integral zip has been specially developed for easier slipping-on. Finally, it comes with anti-odor & antimicrobial ATR® treatment. Ideal for young BMX and VTT pilots.

/IT

Il gilet MOTION TOP KID 2 è la protezione per bambini più efficace e co-moda (dai 6 anni in su). Leggero e traspirante grazie alla mesh tecnica, integra la SAS-TEC® su schiena, spalle e gomiti ed è dotato di un cusci-netto traforato in EVA per proteggere torace e costole. Una ZIP è stata sviluppata appositamente per facilitare la vestizione. Infine, è realizzato con trattamento ATR® antiodore e antimicrobico. Ideale per i giovani piloti di BMX e mountain bike.

OUTSHELL
MESH, LYCRA

PROTECTION
SAS-TEC™

WEIGHT
700 GRS



VIPER KID 2

S

D3O[®]



La VIPER KID 2 est une dorsale amovible constituée d'une enveloppe en mesh et néoprène afin de garantir un maximum de confort et de légèreté. Ses bretelles et sa ceinture sont réglables, ce qui rend cet accessoire ergonomique. Elle est dotée de la dorsale D30[®] Viper II homologuée en EPI de deuxième catégorie niveau 2, soit le plus haut niveau de protection que peut offrir une dorsale. Elle est préconisée pour une utilisation en DH et dirt.

/EN

The VIPER KID 2 is a removeable dorsal made with mesh and neoprene in order to offer you maximum confort and lightness. Its shoulders straps and hip belt are adjustable for better ergonomic. It's equipped with D30[®] Viper II dorsal accredited PPE second category (level 2), being the highest protection level for a dorsal. We recommend for a DH and Dirt usage.

/IT

VIPER KID 2 è un protettore dorsale rimovibile realizzato in mesh e neo-prene per offrire il massimo del confort e della leggerezza. Le spalline e la cintura sono regolabili per una migliore ergonomia. È dotato del sistema D30[®] Viper II DPI approvato livello 2, il livello di protezione più elevato per un protettore dorsale. Se ne consiglia l'uso per DH e Dirt.

OUTSHELL
MESH, NEOPRENE

PROTECTION
D30[®]

WEIGHT
640 GRS



TURTLE VEST 3

XXS - XS - S

SAS-TEC
body protection systems



Le TURTLE VEST 3 est un gilet de protection idéal pour les jeunes riders. Il est composé de lycra, de mesh et d'un zip frontal pour un confort et un ajustement parfait. Son élasticité permet de s'adapter à toutes les morphologies. Il est doté de la dorsale SAS TEC[™] qui reste souple et très confortable. Idéal pour le BMX, le VTT et le ski. Il est homologué CE niveau 1.

/EN

The TURTLE VEST 3 back protector is the perfect mid-layer gear for young riders. Made with neoprene and mesh, it features a large front zipper to ensure optimum ergonomics and breathability. Its inside SAS TEC[™] back protector is EC homologated.

/IT

Il paraschiena TURTLE VEST 3 è l'attrezzatura perfetta per i giovani ciclisti. Realizzato in neoprene e mesh, è dotato di una ZIP frontale per garantire un'ergonomia e una traspirabilità ottimali. Il paraschiena interno SAS-TEC[™] è dotato del marchio CE.

OUTSHELL
LYCRA, NEOPRENE

PROTECTION
SAS-TEC[™]

WEIGHT
395 GRS



GENOUILLÈRES, COUDIÈRES & SHORT ADULTES

KNEE PADS | ELBOW PADS | SHORT



MOTION KNEE 2

S - M - L - XL



Les genouillères MOTION KNEE 2 possèdent la particularité de pouvoir être retirées sans avoir à déchausser via un zip latéral YKK®. Elles possèdent les derniers pads de protection en D30® (amovibles) et un renfort en Rubbertec™ sur un tissu stretch en Aramide au niveau des genoux. Pour éviter de glisser elles sont dotées de bandes de silicone antidérapantes et de velcros réglables. L'utilisation d'Airprène™ et du nouveau mesh ultra technique confère au produit un très bon maintien et laisse facilement évacuer la transpiration. Ces protections, grâce au nouveau pad D30 LP1, couvrent un large panel de pratiques allant du trail / enduro jusqu'au Bike Park ou la DH. Ce sont les protections officielles du Team enduro RACER. Elles sont homologuées CE niveau 1.

/EN

The MOTION KNEE 2 knee guards have the unique feature of being able to be removed without having to take off your shoes via a YKK® side zip. They have the latest D30® protection pads (removable) and a Rubbertec™ reinforcement on an Aramid stretch fabric at the knees. Non-slip silicone strips are present to prevent slippery in addition to an adjustable Velcro. The use of Airprène™ and the new ultra-technical mesh gives the product a very good support and lets perspiration easily wick out. These protections, thanks to the new D30 LP1 pad, cover a wide range of practices from trail / enduro to Bike Park or DH. They are CE level 1 approved.

/IT

Le ginocchiere MOTION KNEE 2 hanno la particolarità di poter essere rimosse senza dover togliere le scarpe tramite una zip laterale YKK®. Sono munite dei nuovissimi cuscinetti protettivi D30® (rimovibili) e di un rinforzo in Rubbertec™ su un tessuto stretch in fibra aramidica al livello delle ginocchia. Per evitare di scivolare sono dotate di fasce in silicone antiscivolo e chiusure a velcro regolabili. L'utilizzo di Airprène™ e del nuovo tessuto mesh ultra-tecnico conferisce al prodotto un ottimo supporto e consente una traspirazione rapida del sudore. Queste protezioni, grazie agli inserti D30 LP1, le rendono adatte per una vasta gamma di discipline, dal trail/enduro, al bike park, al downhill. Omologate CE livello 1

OUTSHELL

AIRPRENE-STRETCH
MIXED MESH /
ARAMIDE

PROTECTION

D30®

WEIGHT

500 GRS



MOTION ELBOW 2

S - M - L - XL

D3O²



Les coudières MOTION ELBOW 2 ont été conçues pour être ultra légères et fines sans aucun compromis sur la protection. Elles possèdent une protection en D3O[®] spécialement dessinée pour être très ergonomique et épouser au mieux les mouvements du coude. Pour éviter de glisser elles sont dotées de bandes de silicone antidérapantes. Le mix Lycra et Mesh technique assure un très bon maintien et une légèreté incomparable. Grâce à l'utilisation de tissu stretch Aramide sur les mousses en D3O[®], les coudières sont très résistantes. Les MOTION ELBOW 2 sont homologuées CE niveau 1.

/EN

Elbow guards MOTION ELBOW 2 have been designed to be ultra-light, thin, and without any compromise on protection. They have a D3O[®] protection specially developed to be very ergonomic and to follow the movements of the elbow. They come with non-slip silicone strips to prevent slipping. The Lycra and technical Mesh blend ensure a very good support and an unrivaled lightness. Thanks to the use of Aramid stretch fabric on the D3O[®] foam, the elbow pads are very resistant. The MOTION ELBOW 2 are CE level 1 approved.

/IT

Le gomitiere MOTION ELBOW 2 sono state progettate per essere ultraleggere e sottili senza compromessi sulla sicurezza. Hanno una protezione in D3O[®] appositamente progettata per essere molto ergonomica e accompagnare al meglio i movimenti del gomito. Per evitare di scivolare sono dotate di fasce in silicone antiscivolo e chiusure a velcro regolabili. Il mix di lycra e mesh tecnico assicura un ottimo supporto e una leggerezza ineguagliabile. Grazie all'utilizzo di tessuto stretch in fibra aramidica sulle schiume D3O[®], queste gomitiere si rivelano molto resistenti. Le MOTION ELBOW 2 sono omologate CE livello 1.

OUTSHELL

ARAMIDE-STRETCH
LYCRA / MESH

PROTECTION

D3O[®]

WEIGHT

180 GRS



PROFILE KNEE

M - L - XL

D3O²



Les genouillères PROFILE KNEE sont des protections ergonomiques très abouties. Elles offrent le plus haut niveau de protection de la collection grâce à leurs pads en D3O[®] LP1 EVO et sont extrêmement souples et confortables. Elles possèdent un renfort en Aramid™ et des inserts en D3O[®] autour des articulations. Pour éviter de glisser elles sont dotées de bandes antidérapantes et de velcros réglables. Elles sont homologuées CE niveau 2.

/EN

The PROFILE knee & elbow pads are ergonomic and very well designed protections. They offer the highest level of protection in the collection thanks to their D3O[®] LP1 EVO pads and are extremely soft and comfortable. They have a reinforcement in Aramid™ and D3O[®] reinforcements around the joints. To prevent slipping, they are equipped with non-slip strips and adjustable velcros. It is CE Level 2 Homologated

/IT

Le protezioni per ginocchia e gomiti PROFILE KNEE e PROFILE ELBOW offrono il massimo livello di protezione grazie ai cuscinetti D3O[®] T5 e ai rinforzi Aramid, il che le rende ergonomiche, flessibili e quindi comode. Per evitare scivolamenti, sono state dotate di strisce di silicone anti-scivolo e di velcro. L'uso del neoprene ventilato garantisce un'evacuazione facile della traspirazione.

OUTSHELL

AIRPRENE- STRETCH
ARAMID, MESH

PROTECTION

D3O[®]

WEIGHT

640 GRS



PROFILE ELBOW

M - L - XL

D3O²



Les coudières et genouillères PROFILE sont des protections ergonomiques très abouties. Elles offrent le plus haut niveau de protection de la collection grâce à leurs pads en D3O[®] T5 et sont extrêmement souples et confortables. Elles possèdent un renfort en Aramid™ et des inserts en D3O[®] autour des articulations. Pour éviter de glisser elles sont dotées de bandes antidérapantes et de velcros réglables. Elles sont homologuées CE niveau 2.

/EN

The PROFILE knee & elbow pads are ergonomic and very well designed protections. They offer the highest level of protection in the collection thanks to their D3O[®] LP1 EVO pads and are extremely soft and comfortable. They have a reinforcement in Aramid™ and D3O[®] reinforcements around the joints. To prevent slipping, they are equipped with non-slip strips and adjustable velcros. It is CE Level 2 Homologated

/IT

Le protezioni per ginocchia e gomiti PROFILE KNEE e PROFILE ELBOW offrono il massimo livello di protezione grazie ai cuscinetti D3O[®] T5 e ai rinforzi Aramid, il che le rende ergonomiche, flessibili e quindi comode. Per evitare scivolamenti, sono state dotate di strisce di silicone anti-scivolo e di velcro. L'uso del neoprene ventilato garantisce un'evacuazione facile della traspirazione.

OUTSHELL

AIRPRENE- STRETCH
ARAMID

PROTECTION

D3O[®]

WEIGHT

540 GRS



FLEXAIR COMBO

S - M - L - XL



Le FLEXAIR COMBO est un ensemble de genouillère/protège-tibia doté d'un long pad en gel polyuréthane 3DSP® développé spécialement par notre bureau d'étude. Idéal pour le BMX et le VTTAE, ce combo est doté de 3 scratchs au dos qui le rende facile à mettre en place et à retirer. Sa construction en lycra et mesh le rende souple et très confortable. Il est homologué CE niveau 1.

/EN

The FLEXAIR COMBO is a set of knee and shin pads, featuring a long 3DSP® polyurethane gel pad, specially developed by our design office. Ideal for BMX and MTB, this combo has 3 velcro straps on the back, which makes it easy to put on and take off. Its lycra and mesh construction makes it soft and very comfortable.

/IT

Il FLEXAIR COMBO è un set di protezioni per ginocchia/tibia con un lungo cuscinetto in gel poliuretano 3DSP® sviluppato appositamente dal nostro ufficio di progettazione. Ideale per BMX ed e-MTB, questa combinazione ha 3 velcri sul retro che rende il set facile da indossare e da togliere. Grazie alla sua composizione in lycra e mesh, la protezione è flessibile e molto confortevole.

OUTSHELL

LYCRA, MESH

PROTECTION

3DSP

WEIGHT

400 GRS



FLEXAIR KNEE

S - M - L - XL



Nos genouillères FLEXAIR KNEE sont le fruit de 2 années de tests et de recherches. Conçues autour d'une enveloppe en mesh et lycra elles reçoivent un pad en gel polyuréthane 3DSP® à haute capacité d'absorption développé spécialement par notre bureau d'étude. Pour les maintenir en place elles possèdent des bandes de silicones antidérapantes. Les FLEXAIR KNEE ont été approuvées par les pilotes pros du Team Racer en BMX et en Enduro.

/EN

The FLEXAIR KNEE are conceived around a mesh and lycra envelope and a polyurethane gel pad with a high absorption power. To stay still, we added non-slip silicon strips. They were tested and approved by the Team RACER BMX and Enduro.

/IT

Le ginocchiere FLEXAIR KNEE sono realizzate intorno a una busta in mesh e lycra e a un cuscinetto in gel poliuretano ad alto potere as-sorbente. Per tenerle ferme, abbiamo aggiunto strisce di silicone anti-scivolo. Sono state testate e approvate dal Team RACER BMX ed Enduro.

OUTSHELL

LYCRA, MESH

PROTECTION

3DSP

WEIGHT

340 GRS



RACER

FLEXAIR ELBOW

S - M - L - XL



Nos coudières FLEXAIR ELBOW sont le fruit de 2 années de tests et de recherches. Conçues autour d'une enveloppe en mesh et lycra elles reçoivent un pad en gel polyuréthane 3DSP® à haute capacité d'absorption développé spécialement par notre bureau d'étude. Pour les maintenir en place elles possèdent des bandes de silicones antidérapantes. Les FLEXAIR ELBOW ont été approuvées par les pilotes pros du Team Racer en BMX et en Enduro.

/EN

The FLEXAIR ELBOW are conceived around a mesh and lycra envelope and a polyurethane gel pad with a high absorption power. To stay still, we added non-slip silicon strips. They were tested and approved by the Team RACER BMX and Enduro.

/IT

Le gomitiere FLEXAIR ELBOW sono realizzate intorno a una busta in mesh e lycra e a un cuscinetto in gel poliuretano ad alto potere as-sorbente. Per tenerle ferme, abbiamo aggiunto strisce di silicone anti-scivolo. Sono state testate e approvate dal Team RACER BMX ed Enduro.

OUTSHELL

LYCRA, MESH

PROTECTION

3DSP

WEIGHT

300 GRS



MOUNTAIN KNEE 2

S - M - L - XL



Les MOUNTAIN KNEE 2 sont de nouvelles genouillères dédiées au trail et au all-mountain qui se veulent plus légères et confortables que leurs devancières. Dotées de pads en D3O™ et mousse EVA elles offrent un haut niveau de protection. Conçues à partir de matériaux souples et légers tels que le lycra et le mesh, elles seront un allié de choix en toute circonstances. Pour éviter de glisser elles sont dotées de bandes de silicones antidérapantes. Les MOUNTAIN KNEE 2 sont homologuées CE niveau 1.



/EN

THE MOUNTAIN 2 knee, dedicated to the trail and all mountain, are the lightest and most comfortable products. Made with D3O® pads, they offer high protection level. Conceived with soft and light materials as mesh and lycra, they will be a real asset. To stay still, we added non-slip silicon strips and Velcro.

OUTSHELL
LYCRA, MESH

PROTECTION
D3O®

WEIGHT
240 GRS

/IT

Le ginocchiera MOUNTAIN KNEE 2, dedicato a trail e all mountain, sono i prodotti più leggeri e confortevoli. Realizzate con cuscinetti D3O®, offrono un livello di protezione elevato. Concepite con materiali morbidi e leggeri come mesh e lycra, rappresenteranno una vera e propria ri-sorsa. Per tenerle ferme, abbiamo aggiunto strisce di silicone e velcro antiscivolo.

MOUNTAIN ELBOW 2

S - M - L - XL



Les MOUNTAIN ELBOW 2 sont de nouvelles coudières dédiées au trail et au all-mountain qui se veulent plus légères et confortables que leurs devancières. Dotées de pads en D3O® et mousse EVA elles offrent un haut niveau de protection. Conçues à partir de matériaux souples et légers tels que le lycra et le mesh, elles seront un allié de choix en toute circonstances. Pour éviter de glisser elles sont dotées de bandes de silicones antidérapantes. Les MOUNTAIN ELBOW 2 sont homologuées CE niveau 1.



/EN

THE MOUNTAIN 2 elbow, dedicated to the trail and all mountain, are the lightest and most comfortable products. Made with D3O® pads, they offer high protection level. Conceived with soft and light materials as mesh and lycra, they will be a real asset. To stay still, we added non-slip silicon strips and Velcro.

OUTSHELL
LYCRA, MESH

PROTECTION
D3O®

WEIGHT
180 GRS

/IT

Le gomitiere MOUNTAIN ELBOW 2, dedicato a trail e all mountain, sono i prodotti più leggeri e confortevoli. Realizzate con cuscinetti D3O®, offrono un livello di protezione elevato. Concepite con materiali morbidi e leggeri come mesh e lycra, rappresenteranno una vera e propria ri-sorsa. Per tenerle ferme, abbiamo aggiunto strisce di silicone e velcro antiscivolo.

PROFILE SHORT 2

S - M - L - XL



Le PROFILE SHORT 2 est un sous vêtement doté de protections D3O® intégrées sur les hanches et les cuisses. Il possède une peau technique afin de protéger l'entre jambe tel un cuissard cycliste. Il est constitué de mesh et de lycra extensible laissant évacuer la transpiration tout en offrant un haut niveau de confort. Il est homologué CE niveau 1.



/EN

The PROFILE SHORT 2 is an undergarment, with D3O® protectors fitted to the hips and thighs. It has a technical skin to protect the crotch, like cycling shorts. It is made of mesh and stretch lycra, allowing perspiration to disperse, while offering a high level of comfort.

OUTSHELL
LYCRA, MESH

PROTECTION
D3O®

WEIGHT
340 GRS

/IT

Il PROFILE SHORT 2 è un articolo d'intimo dotato di protezioni D3O® su fianchi e cosce. È rivestito da una pelle tecnica per proteggere il cavallo come un pantaloncino da ciclismo. È realizzato in mesh e lycra elasticizzata, per agevolare la traspirazione offrendo un elevato livello di comfort.

ANTI-SHOX

35/38 - 39/42 - 43/46

D3O[®]

Les ANTI-SHOX sont des chaussettes de protection qui intègrent des pads en D3O[®] sur les tibias et les malléoles, conférant ainsi un haut niveau de protection contre les chocs et les projections. Leur construction en coton et polyamide apporte un très bon confort et une bonne évacuation de la transpiration. Un must pour les descendeurs, freeriders et BMXers.

/EN

ANTI-SHOX are protective socks that have D3O[®] pads on the shins and malleoli, thus conferring a high protection level against shocks and projections. Their construction in cotton and polyamide brings a very good comfort and wick away perspiration. A must for the downhill riders, freeriders and BMXers.

/IT

Gli ANTI-SHOX sono calzini protettivi dotati di cuscinetti D3O[®] su stinchi e malleoli, che in tal modo garantiscono un elevato livello di protezione da urti e proiezione. La loro costruzione in cotone e poliamide garantisce un comfort ottimale e allontana il sudore. Un must per ciclisti, free-rider e BMXer.

OUTSHELL

COTON, ELASTHAN

PROTECTION

D3O[®]

WEIGHT

110 GRS



GENOUILLÈRES, COUDIÈRES & SHORT ENFANTS

KID KNEE PADS | ELBOW PADS | SHORT

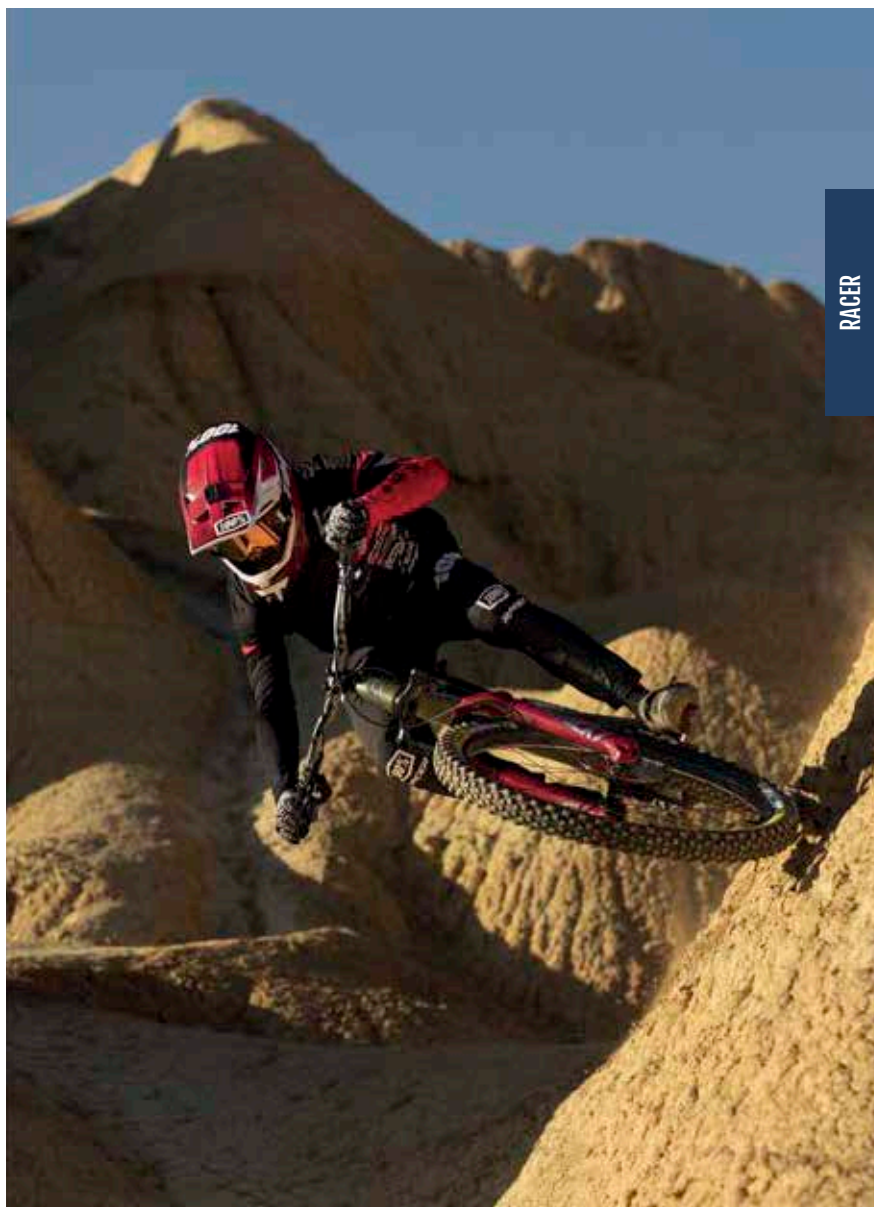

RACER

MOUNTAIN SHORT KID

SAS-TEC
body protection systems

6Y / 8Y / 10Y



Le MOUNTAIN SHORT KID est un sous vêtement doté de protections SAS-TEC® intégrées sur les hanches et les cuisses uniquement destiné aux enfants. Une mousse supplémentaire de protection est située au niveau du coccyx. Il possède une peau technique afin de protéger l'entre jambe tel un cuissard cycliste. Il est constitué de mesh et de lycra extensible laissant évacuer la transpiration tout en offrant un haut niveau de confort. Son look est à la fois sportif et tendance. Il est homologué CE niveau 1.

/EN

The MOUNTAIN SHORT KID is a padded liner with integrated SASTEC® protection on the hips and thighs, designed for children only. An additional protective foam is located at the coccyx. It has a technical chamois to protect the crotch. It is made of mesh and lycra stretch to evacuate perspiration while offering a high level of comfort. Its look is both sporty and trendy. It is CE level 1 approved.

OUTSHELL

LYCRA, MESH

PROTECTION

SAS-TEC®

WEIGHT

220 GRS

/IT

Il MOUNTAIN SHORT KID è un indumento intimo munito di protezioni SASTEC® integrate su fianchi e cosce - solo per bambini. Al livello del cocchige è posizionato uno strato di schiuma protettiva supplementare. Un rivestimento in pelle tecnica protegge il cavallo come un pantaloncino da ciclista. È realizzato in tessuto mesh e lycra elasticizzata, per agevolare la traspirazione offrendo un elevato livello di comfort. Il suo look è al tempo stesso sportivo e di tendenza. Omologato CE livello 1.



MOUNTAIN KNEE KID

D3O[®]

6Y / 8Y / 10Y



La genouillère MOUNTAIN KNEE KID est destinée aux jeunes riders de BMX ou de VTT. Elle est dotée d'un pad constitué de 2 mousses D30® de différentes densités. Elles recouvrent ergonomiquement le genou et le haut tibia. La construction de cette genouillère en lycra, en mesh et en stretch Aramide la rend à la fois souple et confortable. Pour éviter de glisser elles sont dotées de bandes de silicones antidérapantes. Les MOUNTAIN KNEE KID sont homologuées CE niveau 1.

/EN

The knee guard MOUNTAIN KNEE KID is designed for young BMX or mountain bike riders. It gets a pad made of 2 different D30® foam layers. They ergonomically cover the knee and upper shin. The construction of this knee pad in lycra, mesh and stretch Aramid makes it both flexible and comfortable. They come with non-slip silicone strips to prevent slippery. The MOUNTAIN KNEE KID are CE level 1 approved.

OUTSHELL

ARAMID STRETCH
LYCRA, MESH

PROTECTION

D30®

WEIGHT

200 GRS

/IT

La ginocchiera MOUNTAIN KNEE KID è pensata per i giovani ciclisti di BMX o MTB. È dotata di un inserto costituito da 2 schiume D30® di diversa densità, che coprono ergonomicamente il ginocchio e la parte superiore della tibia. La struttura di questa ginocchiera in lycra, mesh e stretch in fibra aramidica la rende al tempo stesso morbida e confortevole. Per evitare di scivolare, la ginocchiera è munita di fasce in silicone antiscivolo. Omologata CE livello 1.



GANTS ÉTÉ

SUMMER GLOVES



DIGGER

S/7 - M/8 - L/9 - XL/10 - XXL/11

D3O®



Le DIGGER offre un équilibre parfait entre confort et protection. Il possède une coque en D3O® ainsi que des renforts sur les doigts et la paume. Pour assurer une bonne respirabilité il est composé de mesh et d'une paume perforée. Enfin, il intègre un index tactile, une éponge microfibre et des bandes de silicone antidérapantes. Sa fermeture est assurée par un velcro.

/EN

The DIGGER glove is the perfect balance between comfort and protection. It features a flexible D3O® knuckle and some reinforced protections on both palm and fingers. Its mesh composition and perforated palm ensures great breathability. It also includes a touchscreen index, a thumb sponge and non-skid silicone strips. The lock system is assured via a velcro.

/IT

El guante DIGGER ofrece el equilibrio perfecto entre comodidad y protección. Cuenta con una zona D3O® flexible en los nudillos y varios protectores reforzados tanto en la palma como en los dedos. La composición de malla con la palma perforada garantiza una gran transpirabilidad. También incluye un índice compatible con pantallas táctiles, una esponja en el pulgar y tiras de silicona antideslizantes. El cierre es de velcro.

OUTSHELL

PREMIUM LEATHER
MESH, NEOPRENE

PALM

CLARINO,
TACTILE INDEX

PROTECTION

D3O®



047

070

ROCK 3

XS/6 - S/7 - M/8 - L/9 - XL/10 - XXL/11 - XXXL/12

D3O®



Le ROCK 3 s'offre un nouveau tissu en Cordura pour encore plus de confort et de protection. Il intègre une coque souple en D3O® sur le dessus de la main et des pads sur la paume et les phalanges. Il possède aussi des bandes de silicone antidérapantes et une éponge destinée à essuyer la transpiration et des index tactiles évitant d'avoir à dégrafer. Son maintien est assuré par un velcro de serrage en TPR au poignet. Il est homologué CE niveau 1.

/EN

The ROCK 3 features a new Cordura fabric for even more comfort and protection. It incorporates a soft D3O® shell on the top of the hand and pads on the palm and knuckles. It also has non-slip silicone strips, a sponge for wiping away perspiration and tactile indexes to avoid having to deglove. It is held in place by a velcro fastener on the wrist.

/IT

Il ROCK 3 presenta un nuovo tessuto in Cordura per una ulteriore comodità e protezione. È composto da un morbido rivestimento in D3O® sulla parte superiore della mano e da cuscinetti su palmo e falangi. Presenta inoltre fasce in silicone antiscivolo e una spugna studiata per asciugare il sudore e indici tattili per evitare di dover togliere i guanti. La tenuta e la stabilità sono assicurate dalla chiusura con il velcro al polso.

OUTSHELL

CORDURA,
NEOPRENE

PALM

CLARINO,
TACTILE INDEX

PROTECTION

D3O®



746

070

002

317

AIR RACE 3

S/7 - M/8 - L/9 - XL/10 - XXL/11 - XXXL/12

Le AIR-RACE 3 est un gant extrêmement confortable ayant une excellente ventilation grâce à sa construction en mesh. Sa paume en clarino très aéré aborde des coutures extérieures, des bandes de silicone antidérapantes ainsi qu'une éponge microfibre. Il possède des index tactiles permettant de manipuler les smartphones. Son maintien est assuré par un velcro au poignet.

/EN

The AIR RACE 3 is an incredibly comfortable glove with great ventilation thanks to its mesh construction. The clarino palm bears some outer seams, non-skid silicone strips and a sponge to whip moisture. The glove is touchscreen compatible and locking system is ensured through a velcro.

/IT

AIR RACE 3 è un guanto incredibilmente comodo con un'ottima ventilazione grazie alla sua costruzione in mesh. Il palmo in clarino è dotato di cuciture esterne, strisce di silicone antiscivolo e di una spugna per eliminare l'umidità. Il guanto è tattile e il sistema di bloccaggio è garantito grazie a un velcro.

OUTSHELL

MESH,
3D NEOPRENE

PALM

CLARINO,
TACTILE INDEX



101

743

424

809

058

IRON

XS/6 - S/7 - M/8 - L/9 - XL/10 - XXL/11

Le modèle IRON est un gant en lycra recouvert d'éléments en rubber lui donnant un look affirmé tout en apportant une protection contre les projections et les frottements. Sa paume en cuir d'agneau apporte un grand niveau de souplesse, de grip et une excellente résistance à l'abrasion. Il possède des index tactiles permettant d'utiliser votre smartphone ou votre GPS sans avoir à dégrafer.

/EN

The IRON model is a lycra glove covered with rubber elements giving it a strong look while providing protection against projections. Its lambskin palm provides a high level of flexibility, grip and excellent abrasion protection. It has tactile indexes that allow you to use your smartphone or GPS without having to unsheath.

/IT

Il modello IRON è un guanto in lycra con elementi in gomma che gli conferiscono un aspetto robusto e allo stesso tempo lo proteggono dagli schizzi. Il palmo in pelle di agnello offre un alto livello di flessibilità, aderenza e un'eccellente protezione dall'abrasione. È dotato di indici tattili che consentono di utilizzare lo smartphone o il GPS senza doverlo sguainare.

OUTSHELL

LYCRA

PALM

PREMIUM LEATHER



002

009

FACTORY

XS/6 - S/7 - M/8 - L/9 - XL/10 - XXL/11

Le FACTORY est le gant réplique du team Enduro Collective qui court en Coupe du Monde EWS. C'est l'équivalent d'une seconde peau tellement son fit est ajusté. Sa paume en cuir d'agneau confère un grip exceptionnel et sa construction en lycra le rend extrêmement souple et confortable. Un gant parfait pour les compétiteurs à la recherche d'un produit pensé pour la race.

/EN

The FACTORY is the Enduro Collective glove's replica while riding the EWS. This glove is so fitted that it feels like a second skin. The lamb leather used on the palm gives it an exceptional grip and its lycra construction makes it incredibly flexible and comfortable. The perfect glove for competitors looking for a racing product.

/IT

FACTORY è la replica del guanto della squadra Enduro Collective durante le gare di EWS. Questo guanto è così aggiustamento da sembrare una seconda pelle. La pelle di agnello utilizzata sul palmo garantisce una presa ottimale e la sua costruzione in lycra lo rende incredibilmente flessibile e confortevole. Il guanto perfetto per coloro che desiderano un prodotto per le gare.

OUTSHELL

LYCRA

PALM

PREMIUM LEATHER



002

UNION

S/7 - M/8 - L/9 - XL/10 - XXL/11

Le modèle UNION est un gant en lycra sobre et élégant qui possède une paume en cuir d'agneau lui conférant souplesse, grip et une excellente protection à l'abrasion. Il possède des index tactiles permettant d'utiliser votre smartphone ou votre GPS sans avoir à déganter.

/EN

The UNION model is a sober and elegant lycra glove with a lambskin palm for flexibility, grip and excellent abrasion protection. It has tactile indexes allowing you to use your smartphone or GPS without having to unsheathe.

/IT

UNION è un guanto in lycra semplice ed elegante con palmo in pelle d'agnello che garantisce flessibilità, presa ed eccellente protezione dalle abrasioni. È dotato di indici tattili che consentono di utilizzare lo smartphone o il GPS senza doverlo sguainare.

OUTSHELL

LYCRA

PALM

PREMIUM LEATHER



002



009



032



017



007

LIGHT SPEED 4

S/7 - M/8 - L/9 - XL/10 - XXL/11

Le LIGHT-SPEED 4 est un gant minimaliste étudié pour les pilotes à la recherche d'un équipement super light. Il offre un haut niveau de confort et de respirabilité grâce à l'utilisation massive de mesh. Sa paume en clarino perforé aborde des bandes de silicone antidérapantes, un index tactile et une éponge destinée à essuyer la transpiration. Le choix des teams de BMX DN1.

/EN

The LIGHT-SPEED 4 is a true minimalistic glove designed for riders looking for ultra-light equipment. It provides a high level of comfort thanks to its outer seams and the massive use of mesh. The glove is touchscreen compatible and has a stretch cuff for a snug, but comfortable fit. Its clarino palm and anti-slip silicon bands offer an excellent handlebar feel. The RACER BMX team choice.

/IT

LIGHT-SPEED 4 è un autentico guanto minimalista progettato per i ciclisti che desiderano attrezzature ultraleggere. Offre un elevato livello di comfort grazie alle cuciture esterne e all'utilizzo massiccio del mesh. Il guanto è tattile e dotato di un polsino elasticizzato per una vestibilità aderente ma confortevole. Il palmo in clarino e le fasce in silicone anti-civolo offrono un'ottima sensazione a contatto con il manubrio. La scelta del team RACER BMX.

OUTSHELL

LYCRA,
NEOPRENE

PALM

CLARINO - TACTILE
INDEX



044



018



743



189



058

GP STYLE 2

XS/6 - S/7 - M/8 - L/9 - XL/10 - XXL/11 - XXXL/12

Le GP STYLE 2 est un modèle de confort et de dextérité. Constitué de lycra sur le dessus de la main et de clarino en paume, il aborde des bandes de silicone antidérapantes, un index tactile et une éponge destinée à essuyer la transpiration. Son maintien est assuré par un velcro de serrage en néoprène au poignet.

/EN

GP STYLE 2 is all about comfort and dexterity. It features a single layer lycra palm and a lycra on the top. The glove also comes with non-slip silicon bands and a sponge for wiping perspiration. Wrist fit is handled with a Velcro neoprene strap. Our enduro team athletes perform with GP STYLE.

/IT

GP STYLE 2 è sinonimo di comfort e manualità. È fatto di lycra sul palmo e di lycra nella parte superiore della mano. Il guanto è inoltre dotato di fasce antiscivolo in silicone e di una spugna per asciugare il sudore. La vestibilità del polso è garantita grazie a una cinghia rinforzata con velcro neoprene. I nostri atleti del team enduro si esibiscono con GP STYLE.

OUTSHELL

LYCRA, NEOPRENE

PALM

CLARINO,
TACTILE INDEX



174

044

743

077

018

GP STYLE

XS/6 - S/7 - M/8 - L/9 - XL/10 - XXL/11 - XXXL/12

Le GP STYLE est un modèle de confort et de dextérité. Constitué de mesh sur le dessus de la main et de clarino en paume, il aborde des bandes de silicone antidérapantes, un index tactile et une éponge destinée à essuyer la transpiration. Son maintien est assuré par un velcro de serrage en TPR au poignet.

/EN

GP STYLE is all about comfort and dexterity. It features a single layer clarino palm and a mesh on the top. The glove also comes with non-slip silicon bands and a sponge for wiping perspiration. Wrist fit is handled with a Velcro TPR reinforced strap. Our enduro team athletes perform with GP STYLE.

/IT

GP STYLE è sinonimo di comfort e manualità. È fatto di clarino sul palmo e di mesh nella parte superiore della mano. Il guanto è inoltre dotato di fasce antiscivolo in silicone e di una spugna per asciugare il sudore. La vestibilità del polso è garantita grazie a una cinghia rinforzata con velcro TPR. I nostri atleti del team enduro si esibiscono con GP STYLE.

OUTSHELL

MESH, NEOPRENE

PALM

CLARINO,
TACTILE INDEX



002

790

375

MITAINES

INGERLESS GLOVES



IZOAR

S/7 - M/8 - L/9 - XL/10 - XXL/11

IZOAR est une mitaine aéro légère destinée à un usage route et/ou XC. Sa construction en lycra confère un très haut niveau de confort et de ventilation. Elle possède une éponge destinée à essuyer la transpiration et des plots sur les doigts afin d'en faciliter le retraitage.

/EN

IZOAR is a mitten for road bike, very light thanks to its construction in perforated mesh and lycra. It comes with a long cuff, thin but reinforced palm for better grip and comfort, and a microfiber terry thumb.

/IT

IZOAR è un guanto per bici da strada, molto leggero grazie alla sua costruzione in rete traforata e lycra. Viene fornito con un polsino lungo, palmo sottile ma rinforzato per una migliore presa e comfort e un pollice in spugna di microfibra.

OUTSHELL
LYCRA

PALM
MESH, CLARINO

PROTECTION
REINFORCEMENTS



002

081

GALIBIER 2

XS/6 - S/7 - M/8 - L/9 - XL/10 - XXL/11

Le GALIBIER 2 est une mitaine légère destinée à un usage route et/ou XC. Sa construction en mesh et ses renforts anti-vibrations en gel sur la paume confèrent un très haut niveau de confort et de ventilation. Elle possède une éponge destinée à essuyer la transpiration et des plots sur les doigts afin d'en faciliter le retraitage.

/EN

The GALIBIER 2 is a mitten thought out for XC, road or trail riding. Its construction made of lycra makes it very comfortable while its clarino palm features gel pads to offer an excellent handlebar feel. It also provides a sponge for wiping perspiration and leash between fingers to facilitate the pull out. Wrist fit is handled with a Velcro TPR reinforced strap.

/IT

GALIBIER 2 è un guanto pensato per XC, ciclismo su strada o trail riding. La sua costruzione in lycra lo rende molto comodo mentre il palmo in clarino presenta cuscinetti in gel che offrono un'ottima sensazione a contatto con il manubrio. Inoltre, è dotato di una spugna per asciugare il sudore e di un laccio tra le dita per facilitare l'estrazione. La vestibilità del polso è garantita grazie a una cinghia rinforzata con velcro TPR.

OUTSHELL
MESH, LYCRA

PALM
MESH, CLARINO

PROTECTION
GEL PADS



174

GANTS ENFANTS

KIDS GLOVES



ROCA KID 2

XXS/6Y - XS/8Y - S/10Y

Le ROCA KID 2 est constitué de spandex et de clarino en paume et possède une coque de protection souple Viscolab®. Un velcro vient fermer la manchette et des protections en gel sur la paume complètent le haut niveau de protection. Enfin il intègre des index tactiles permettant de manipuler les smartphones. Ce modèle répond parfaitement aux exigences des parents les plus attentifs.

/EN

The ROCA KID 2 is a lightweight and ultra-comfortable glove adapted to the children's morphology. Its ergonomic shell ERGOFLEX® integrated under the spandex ensures a good level of protection. The glove receives a closure flap with a velcro on the wrist. The palm in clarino and the silicone touch ensure an excellent grip level.

/IT

ROCA KID 2 è un guanto leggero e ultra confortevole che si adatta alla sagoma dei bambini. Il guscio ergonomico ERGOFLEX® integrato sotto lo spandex garantisce un buon livello di protezione. Il guanto è dotato di un risvolto di chiusura con velcro sul polso. Il palmo in clarino e il tocco di silicone assicurano un livello di grip ottimale.

OUTSHELL

SPANDEX,
NEOPRENE

PALM

CLARINO,
TACTILE INDEX

PROTECTION

VISCOLAB™



002

TURBO KID

XXS/6Y - XS/8Y - S/10Y

Le **TURBO KIDS** est un gant spécifiquement étudié pour les enfants et jeunes pilotes dès 4 ans. Il possède un large flap sur le dessus de la main pour faciliter son enfilage, une paume en clarino dotée de renforts en mousse, une éponge destinée à essuyer la transpiration et un index tactile. Un must !

/EN

The **TURBO KIDS** is a glove specifically designed for children and young riders from 4 years old. It has a wide flap on the top of the hand for making it easier to put on, a Clarino palm with foam reinforcements, a sponge to wipe away perspiration and a tactile index finger. A must-have!

/IT

Il **TURBO KIDS** è un guanto progettato specificamente per bambini e giovani piloti a partire dai 4 anni. È dotato di un ampio lembo sul dorso della mano per indossarlo facilmente, un palmo in clarino con rinforzi in schiuma, una spugna per asciugare il sudore e un indice tattile. Impossibile non averlo!

OUTSHELL
MESH, NEOPRENE

PALM
CLARINO

PROTECTION
RENFORTS



743

424

LIGHT SPEED 3 KID

XXS/6Y - XS/8Y - S/10Y

Le **LIGHT-SPEED 3 KID** est un gant minimaliste en mesh étudié pour les jeunes pilotes à la recherche d'un gant léger. Sa paume en clarino aborde des bandes de silicone antidérapantes, une éponge destinée à essuyer la transpiration et un index tactile. Le choix des teams de BMX DN1.

/EN

LIGHT SPEED 3 KID is a true minimalist glove designed for young riders who are looking for a very lightweight and thin glove. The back of the glove is a breathable, flexible mesh material and its palm is made of clarino and features anti-slip silicon bands. The **LIGHT SPEED 3 KID** is touchscreen compatible and the thumb is terry cloth backed. **RACER BMX DN1** team athletes perform with the **LIGHT SPEED 3 KID**.

/IT

LIGHT SPEED 3 KID è un vero e proprio guanto minimalista progettato per i giovani ciclisti che sono alla ricerca di un guanto molto leggero e sottile. La parte posteriore del guanto è un materiale in mesh traspirante e flessibile e il palmo è realizzato in clarino e presenta bande antiscivolo in silicone. **LIGHT SPEED 3 KID** è compatibile con il touchscreen e il pollice è rivestito con un tessuto di spugna. Gli atleti del team **RACER BMX DN1** si esibiscono con il **LIGHT SPEED 3 KID**.

OUTSHELL
LYCRA, MESH

PALM
MESH, CLARINO



002

044

018

GP STYLE KID

XXS/6Y - XS/8Y - S/10Y

Le **GP STYLE KID** est un modèle de confort et de dextérité. Constitué de mesh sur le dessus de la main et de clarino en paume, il aborde des bandes de silicone antidérapantes et une éponge destinée à essuyer la transpiration. Son maintien est assuré par un velcro de serrage en TPR au poignet. C'est le gant à tout faire, BMX comme VTT.

/EN

GP STYLE KID is all about comfort and dexterity. It features a single layer clarino palm and mesh ventilated backside. The glove also comes with non-slip silicon bands and a sponge for wiping perspiration. Wrist fit is handled with a Velcro TPR reinforced strap. Whether it is BMX or MTB, it's our functional everyday riding glove for young riders.

/IT

GP STYLE KID è sinonimo di comfort e manualità. È dotato di un palmo monostrato in clarino e la parte superiore è ventilata in mesh. Il guanto è inoltre dotato di fasce antiscivolo in silicone e di una spugna per asciugare il sudore. La vestibilità del polso è garantita grazie a una cinghia rinforzata con velcro TPR. Che si tratti di BMX o MTB, è comunque il nostro guanto funzionale per i giovani ciclisti.

OUTSHELL
MESH, NEOPRENE

PALM
CLARINO,
TACTILE INDEX

PROTECTION
REINFORCEMENTS



002

790

375

GAMME CHAUFFANTE

HEATED RANGE



E-COVER

S (37-39) - M (40-42) - L (43-45) - XL (46-48)

La E-COVER est la première sur-chaussure chauffante destinée exclusivement au cyclisme. Elle possède notre système chauffant iR-WARM® piloté par un microprocesseur permettant de thermoréguler la température et de gagner en autonomie. Le bouton intègre un témoin de batterie pour vous aider à mieux gérer l'utilisation des 3 niveaux de chauffe des 2 batteries Li-on Polymer de 7.4v dont la puissance atteint 2200Ma. La E-COVER associe le néoprène et le softshell pour offrir un haut niveau de confort et de chaleur, aborde des logos réfléchissants et un zip waterproof permettant une chaussure aisée. Elle est compatible avec 99% des chaussures du marché via son scratch de fermeture et son zip.

/EN

The E-COVER is the one and only shoe cover designed for cycling only. Using the newest iR-WARM® system which was developed by RACER 's Research & Development Center. The heating circuit is now controlled by a microprocessor that thermoregulates the glove and provides greater battery autonomy. Together with the French Army Biomedical Center, Racer was able to carry out tests to validate this new technology. The button was completely rethought in order to offer a better ergonomics. In addition, heat and batteries operating time can be adjusted more precisely thanks to a new charging indicator. Besides the smart heating system, E-COVER features softshell and neoprene to offer outstanding comfort and warmth. It comes with a reflective logo and a waterproof zipper to put in on very easily. It is compatible with 99% of the cycling shoes available on the market.

/IT

E-COVER è la prima e l'unica soprascarpa progettata unicamente per il ciclismo. Utilizza il nuovissimo sistema iR-WARM® sviluppato dal centro di ricerca e sviluppo di RACER. Il circuito di riscaldamento è ora controllato da un microprocessore che termoregola la scarpa e fornisce una maggiore autonomia della batteria. In collaborazione con il Centro biomedico dell'esercito francese, Racer è riuscita ad eseguire test per convalidare questa nuova tecnologia. Il pulsante è stato completamente ripensato per offrire una migliore ergonomia. Inoltre, l'autonomia del calore e delle batterie può essere regolata in modo più preciso grazie a un nuovo indicatore di carica. Oltre al sistema di riscaldamento intelligente, E-COVER è realizzata in softshell e neoprene, per offrire il massimo in termini di comfort e calore. È dotata di un logo riflettente e di una zip impermeabile che ne facilita la vestibilità. È compatibile con il 99% delle scarpe da ciclismo disponibili sul mercato.

OUTSHELL

NEOPRENE, IR-WARM SYSTEM, SOFTSHELL

SOLE

SOFTSHELLL, ARAMID

PROTECTION

ARAMID



002

E-GLOVE 4

XS/6 - S/7 - M/8 - L/9 - XL/10 - XXL/11 - XXXL/12

Le E-GLOVE 4 est notre quatrième génération de gant chauffant destiné au cyclisme. Cette nouvelle version est étanche via une membrane waterproof Polymax®. Le cheminement de son fil chauffant a été revu pour passer sous les doigts afin de conférer une meilleure chauffe. La manchette a été allongée et élargie et son zip renforcé. Le circuit chauffant iR-WARM®, piloté par un microprocesseur permet de thermoréguler la température à l'intérieur du gant et de gagner en autonomie. De nombreux tests ont été effectués avec l'Institut de Recherche Biomédicale des Armées afin d'éprouver et de valider l'intégration du système. Le E-GLOVE 4 intègre un témoin de batterie pour vous aider à mieux gérer l'utilisation des 3 niveaux de chauffe. Outre son système chauffant, le E-GLOVE 4 associe le softshell et le clarino pour offrir un confort exceptionnel.

/EN

The E-Glove 4 has been improved for better warming performance and longer battery life. Furthermore, the E-Glove 4 is now waterproof thanks to a Polymax membrane. In order to get you maximum comfort, we associated softshell and clarino. The cuff has been lengthened and widened; the zip has been reinforced. This glove carries reflective logos, silicon stripes and tactile fingers.

/IT

E-Glove 4 è stato migliorato per aumentare le prestazioni di riscaldamento e prolungare la durata della batteria. Inoltre, E-Glove 4 è ora impermeabile grazie a una membrana Polymax. Per offrirti il massimo comfort, abbiamo associato softshell e clarino. Il polsino è stato allungato e allargato; la zip è stata rinforzata. Questo guanto tattile è dotato di loghi riflettenti e strisce in silicone.

OUTSHELL
SOFTSHELL,
IR-WARM SYSTEM

PALM
CLARINO,
TACTILE INDEX

PROTECTION
SHOCK ABSORTION
PADS

MEMBRANE
POLYMAX



174

615

279

797

GANTS HIVER

WINTER GLOVES



RACER

H2O

XS/6 - S/7 - M/8 - L/9 - XL/10 - XXL/11 - XXXL/12

H2O est un gant long en softshell doté d'une membrane étanche Polymax®. Il offre un haut niveau de chaleur grâce à son isolant Fiberfil® sur le dessus de la main et une doublure en polaire Bemberg®. Un zip sur la manchette facilitera son enfilage. Sa paume possède des bandes anti-dérapantes et une large éponge microfibre sur le pouce. Ses index sont compatibles avec la plupart des smartphones. Il a été développé en étroite collaboration avec la célèbre marque de vêtement pour cyclistes avertis, Katusha®.

/EN

The H2O is a mid-length softshell glove with a waterproof Polymax® membrane. Thanks to the Fiberfil® insulation and a Bemberg® fleece lining, it will keep your hands warm and comfortable. A cuff-zip make it easier to slip-on. You'll also find silicon skid-proof's stripes, microfiber terry thumb and tactile fingers.

/IT

H2O è un guanto softshell di media lunghezza con membrana Polymax® impermeabile. Grazie all'isolamento Fiberfil® e alla fodera in pile Bem-berg®, manterrà le tue mani calde e comode. Una zip sul polsino ne facilita la calzatura. Inoltre, è un guanto tattile dotato di strisce antiscivolo in silicone e pollice in spugna di microfibra.

OUTSHELL
SOFTSHELL

PALM
CLARINO,
TACTILE INDEX

PROTECTION
SHOCK ABSORTION
PADS

MEMBRANE
POLYMAX™



002

ALPIN

XS/6 - S/7 - M/8 - L/9 - XL/10 - XXL/11

ALPIN est un modèle mi-long en SCHOELLER® WB400 offrant une excellente protection contre le froid, une grande respirabilité, un confort de premier ordre. Il intègre des coutures extérieures en paumes ainsi que des bandes de silicone, une éponge microfibre sur le pouce et un index tactile. Il a été développé en étroite collaboration avec la célèbre marque de vêtement pour cyclistes avertis, Katusha®.

/EN

Developed with cyclists' apparel brand Katusha®, the ALPIN is a mid-length model. Made from SCHOELLER® WB400, it's breathable though offers dexterity and high cold protection with comfort. You will find silicon skid-proof's stripes, a microfiber terry thumb and tactile fingers.

/IT

Sviluppato con il marchio di abbigliamento per ciclisti Katusha®, ALPIN è un modello di media lunghezza. Realizzato in SCHOELLER® WB400, è traspirante ma offre manualità e un'elevata protezione dal freddo con il massimo del comfort. Inoltre, è un guanto tattile dotato di strisce antiscivolo in silicone e un pollice in spugna di microfibra.

OUTSHELL
SCHOELLER®

PALM
SCHOELLER®,
TACTILE INDEX



002

ROCK WR

XS/6 - S/7 - M/8 - L/9 - XL/10 - XXL/11 - XXXL/12

ROCK WR est la déclinaison hiver et étanche de notre fameux gant ROCK. Comme son homologue il possède une coque de protection D30® sur les os de la main, des pads en gel sur les phalanges et la paume ainsi que des bandes de silicone anti-dérapantes et une fermeture par velcro. De plus il est doté d'un tissu déperlant et d'une membrane lui conférant une excellente protection contre le froid et la pluie. Enfin il aborde des index tactiles et une éponge microfibre sur le pouce. Il est homologué CE niveau 1.

/EN

ROCK WR is the wintery version of the famous ROCK glove, first released in 2015. As the summer version, it comes with a D30® shell for meta-carp's protection, gel pads on palm and phalanx as well as silicon skid-proof's stripes, microfiber terry thumb, tactile fingers and closes with Velcro. Made with water-repellent and waterproof fabrics, the ROCK WR is an excellent protection against cold and rain.

/IT

ROCK WR è la versione invernale del famoso guanto ROCK, lanciato per la prima volta nel 2015. Come per la versione estiva, è un guanto tattile dotato di un guscio D30® per la protezione del metacarpo, cuscinetti in gel su palmo e falange, strisce antiscivolo in silicone, pollice in spugna di microfibra e chiusura con velcro. Realizzato con tessuti idrorepellenti e impermeabili, ROCK WR costituisce un'ottima protezione contro il freddo e la pioggia.

OUTSHELL
LAMINATED,
SOFTSHELL

PALM
CLARINO,
TACTILE INDEX

PROTECTION
D30®



002

D30®
CE

BANKS

S/7 - M/8 - L/9 - XL/10 - XXL/11

Avec son bord côte en laine, le BANKS se destine aux cyclistes urbains ainsi qu'aux cyclistes avertis. Construit autour d'un tissu en nylon Ripstop léger et compressible et d'un isolant Fiberfil, il apporte chaleur et respirabilité. Sa paume en Clarino doté d'index tactiles permettra de manipuler les smartphones et écrans GPS sans avoir à déganter. Son éponge microfibre et ses bandes de silicone anti-dérapantes seront bienvenues lors des journées humides et des longues sorties.

/EN

With its wool ribbed hem, the BANKS is designed for urban cyclists as well as the more experienced cyclist. Built around a lightweight, compressible Ripstop nylon fabric and Fiberfil insulation, it provides warmth and breathability. Its Clarino palm with tactile indexes will allow you to manipulate smartphones and GPS screens without having to deglove. Its microfiber sponge and non-slip silicone strips will be welcome on wet days and long outings.

/IT

Con il suo orlo a coste in lana, il BANKS è progettato per i ciclisti urbani e per i ciclisti più esperti. Costruito su un tessuto di nylon Ripstop leggero e comprimibile e sull'isolamento Fiberfil, offre calore e traspirabilità. Il palmo in Clarino con indici tattili vi permetterà di manipolare gli schermi di smartphone e GPS senza dovervi muovere. La sua spugna in microfibra e le strisce in silicone antiscivolo saranno le benvenute nelle giornate umide e nelle lunghe uscite.

OUTSHELL
RIPSTOP

PALM
CLARINO

INSULATION
FIBERFILL



002

BUCKET

XS/6 - S/7 - M/8 - L/9 - XL/10 - XXL/11

Le BUCKET est fait d'un tissu polaire coupe-vent qui offrira un bon niveau de confort et de chaleur tout en restant respirant. Sa paume en cuir d'agneau apporte un grand niveau de souplesse, de grip et une excellente résistance à l'abrasion. Il possède des index tactiles permettant d'utiliser votre smartphone ou votre GPS sans avoir à déganter.

/EN

The BUCKET is made of a windproof fleece fabric that will provide a good level of comfort and warmth while remaining breathable. Its lambskin leather palm provides a high level of flexibility, grip and excellent protection against abrasion protection. It has tactile indexes allowing you to use your smartphone or GPS without having to unsheathe.

/IT

Il BUCKET è realizzato in un tessuto di pile antivento che offre un buon livello di comfort e calore pur rimanendo traspirante. Il palmo in pelle d'agnello offre un alto livello di flessibilità, aderenza e un'eccellente protezione contro i danni causati dall'uso di sostanze nocive. È dotato di indici tattili che consentono di utilizzare lo smartphone o il GPS senza doverlo sguainare.

OUTSHELL
POLAR

PALM
LEATHER



615

370

UNION WR

S/7 - M/8 - L/9 - XL/10 - XXL/11

Le UNION WR est la version mi-saison du UNION. Constitué d'un tissu heavy lycra déperlant doublé polaire, il saura apporter la touche de chaleur et de confort nécessaire lors des sorties un peu fraîches. Sa paume en cuir d'agneau apporte un grand niveau de souplesse, de grip et une excellente résistance à l'abrasion. Il possède des index tactiles permettant d'utiliser votre smartphone ou votre GPS sans avoir à déganter.

/EN

UNION WR is a mid-season glove made with a water-repellent lycra lined with a fleece. Its sheep palm provides a high level of flexibility, grip and an excellent abrasion protection level. It has tactile index allowing you to use your smartphone or your GPS without removing your glove.

/IT

UNION WR è un guanto da mezza stagione realizzato in lycra idrorepellente foderata in pile. Il suo palmo di pecora offre un alto livello di flessibilità, presa e un'eccellente livello di protezione dall'abrasione. È dotato di indice tattile che consente di utilizzare lo smartphone o il GPS senza togliere il guanto.

OUTSHELL
HEVY LYCRA

PALM
LEATHER



002

STAMP

M/8 - L/9 - XL/10 - XXL/11

Le STAMP est constitué d'un tissu polaire déperlant, il saura apporter la touche de chaleur et de confort nécessaire lors des sorties un peu fraîches. Sa paume, elle aussi constituée de tissu polaire, apportera son lot de souplesse et une protection supplémentaire contre le froid. Il possède des index tactiles permettant d'utiliser votre smartphone ou votre GPS sans avoir à dégrafer

/EN

STAMP is made with a water-repellent lycra lined with a fleece. Its palm provides a high level of flexibility, grip and an excellent abrasion protection level. It has tactile index allowing you to use your smartphone or your GPS without removing your glove.

/IT

STAMP è un guanto realizzato in lycra idrorepellente foderata in pile. Il suo palmo di pecora offre un alto livello di flessibilità, presa e un'eccellente livello di protezione dall'abrasione. È dotato di indice tattile che consente di utilizzare lo smartphone o il GPS senza togliere il guanto.

OUTSHELL
SOFTSHELL

PALM
SOFTSHELL



CHRIS

XS/6 - S/7 - M/8 - L/9

Le CHRIS est un modèle gant sobre et efficace développé pour les femmes évoluant en milieu urbain. Utilisant un tissu polaire coupe-vent en paume et sur le dessus de la main, il offrira un bon niveau de confort et de chaleur tout en restant respirant. Les index tactiles permettront d'utiliser votre smartphone ou votre GPS sans avoir à dégrafer.

/EN

CHRIS is a sober and efficient model developed for women who ride in urban environments. With its windproof fleece fabric on the palm and on the top of the hand, it offers a good level of comfort and warmth. The tactile index allows you to use your smartphone or your GPS without removing your glove.

/IT

CHRIS è un modello sobrio ed efficiente sviluppato per le donne che pedalano in ambienti urbani. Con il suo tessuto in pile antivento sul palmo e sulla parte superiore della mano, offre un buon livello di comfort e calore. L'indice tattile permette di utilizzare lo smartphone o il GPS senza togliere il guanto.

OUTSHELL
SOFTSHELL

PALM
SOFTSHELL



R-PHONE 3

XS/6 - S/7 - M/8 - L/9 - XL/10 - XXL/11

R-PHONE 3 est un gant en doublure polaire équipé d'une matière conductrice sur l'index et le pouce. Vous pourrez ainsi utiliser votre appareil tactile préféré sans retirer vos gants.

/EN

R-PHONE 3 is designed with a conductive material on the forefinger and thumb. It enables you to drive your favorite tactile device without removing your gloves.

/IT

R-PHONE 3 è un guanto attrezzato di una materia conduttrice sull'indice e il pollice. Potete così utilizzare il vostro apparecchio tattile preferito senza ritirare i vostri guanti.

OUTSHELL
POLAR WINDPROOF

PALM
POLAR FLEECE,
TACTILE INDEX



VESTES PLUIE

RAIN JACKETS



RACER

THE PARK

S - M - L - XL

La veste THE PARK a été conçue pour un usage intensif en milieu urbain type 'commuter'. Son tissu très léger aux coutures étanches et coupe-vent vous permettra de rester au sec en cas d'intempéries. THE PARK possède également des aérations dans le dos et sous les aisselles afin de ne pas transpirer, une capuche réglable et des manchettes ajustables. Enfin 4 poches idéalement situées vous permettront de mettre à l'abri vos accessoires indispensables lors de vos déplacements. Elle se range facilement dans un petit sac à dos et pourra vous accompagner lors de toutes vos activités sportives.

/EN

The PARK jacket has been designed for intensive use. Its lightweight fabric with waterproof and windproof seams will keep you dry. The PARK also has vents on the back and under the armpits, an adjustable hood and cuffs. Then 4 pockets will allow you to store your essential accessories during your rides.

/IT

La giacca PARK è stata progettata per un uso intensivo. Il suo tessuto leggero con cuciture impermeabili e antivento vi terrà all'asciutto. La PARK è inoltre dotata di prese d'aria sulla schiena e sotto le ascelle, di cappuccio e polsini regolabili. Le 4 tasche vi permetteranno di riporre gli accessori essenziali durante le vostre uscite.

OUTSHELL
WATERPROOF NYLON



174

018

THE FIELD

S - M - L - XL

THE FIELD est une cape à la coupe moderne dotée d'une silhouette ample et ondulante offrant trois niveaux d'ajustement ainsi qu'une capuche avec cordon de serrage. Son tissu est étanche et déperlant et grâce aux éléments réfléchissants dans le dos, vous pourrez vous déplacer tout en étant bien vus. Conçue avant tout pour les cyclistes, des hanches pour les mains permettent d'assurer une couverture complète même lorsque vous pédalez. THE FIELD est aussi pourvue d'une poche centrale avec rabat aimanté destinée à recevoir la cape une fois pliée et pouvant ensuite servir de banane.

/EN

The FIELD is a modern cut cape with a loose silhouette offering three adjustment levels and a drawstring hood and waterproof fabrics. Designed for cyclists, hand loops ensure full coverage even when you pedaling. The FIELD is also equipped with a central magnetic pocket intended to receive the cape once folded and which can then be used as a bum bag.

/IT

La FIELD è una mantella dal taglio moderno con una silhouette ampia, tre opzioni di regolazione, un cappuccio con coulisse e materiale impermeabile. Progettata per i ciclisti, le cinghie per le mani offrono una copertura completa anche quando si pedala. Il FIELD è inoltre dotato di una tasca magnetica centrale che trattiene il mantello una volta ripiegato e può essere utilizzato come custodia per la cintura.

OUTSHELL
WATERPROOF NYLON



002

ACCESSOIRES

ACCESSORIES

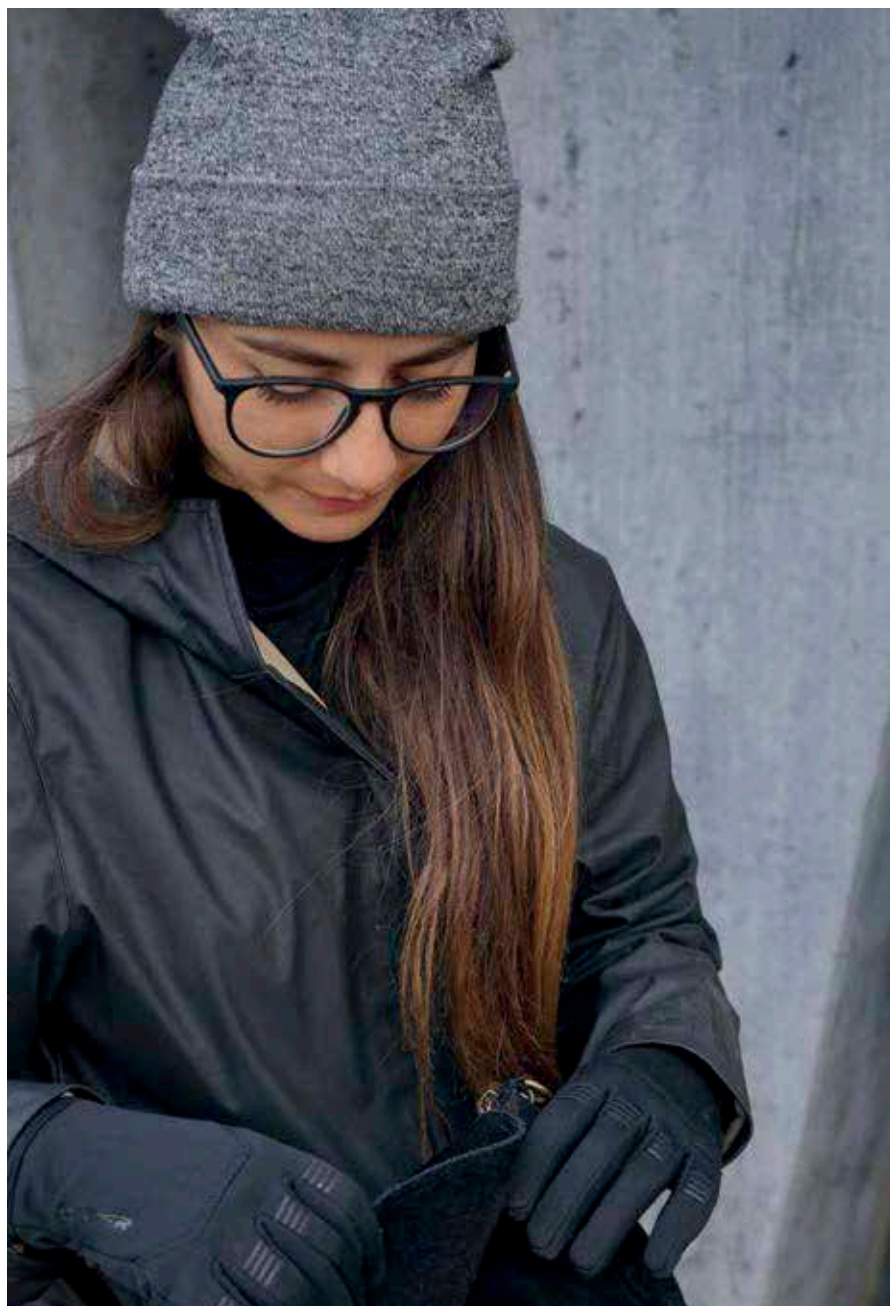



DOUBLE

ONE SIZE FITS ALL



OUTSHELL
POLAR FLEECE, LYCRA



LD600

XS/6 - S/7 - M/8 - L/9 - XL/10 - XXL/11



OUTSHELL
100% SILK



R-WIND

ONE SIZE FITS ALL



OUTSHELL
WINDBREAKER FLEECE



R-FIT

S/M - L/XL



OUTSHELL
GORE® WINDSTOPPER®



RM02

ONE SIZE FITS ALL



OUTSHELL
GORE® WINDSTOPPER®

TECHNOLOGIE ET MATÉRIAUX

PROTECTION - PERFORMANCE ET INNOVATION

La conception d'une gamme imaginée par Racer, intègre les éléments essentiels à toute pratique sportive. De fait, tous nos produits répondent aux besoins suivants : ils doivent être pratiques, confortables, élégants mais aussi et surtout protecteurs, notamment pour les pratiques à risques. C'est pour cela que nous avons décidé de nous associer avec les meilleurs partenaires techniques en termes de protections corporelles.

D3O[®]

RACER[®] x D3O[®]

En 2006 Racer Gloves fut l'une des toutes premières marques à travailler avec la société britannique D3O[®]. Ce matériau magique composé de polymères de couleur orange, a la particularité exceptionnelle de changer son comportement mécanique selon si elle subit une pression lente ou un impact rapide. De manière concrète, lorsqu'on appuie avec son doigt, la matière va rester souple et malléable comme du simple caoutchouc. Cependant si vous venez à frapper la matière d'une manière violente, les composants du D3O[®] vont se lier entre eux pour former une barrière contre les chocs et les vibrations avant de retourner à son état souple. Cette extraordinaire capacité à absorber les chocs doublés par une souplesse et une légèreté exemplaire ont séduit de nombreuses marques et utilisateurs dans les domaines de l'électronique, de la défense et du sport bien évidemment. Racer équipe tous ses produits les plus élaborés de D3O[®], que ce soient les gilets, les gants en passant par les genouillères et les coudières.

In 2006, Racer Gloves was one of the very first brands to work with the British company D3O[®]. This magical material, consisting of orange-coloured polymers, has the exceptional feature of changing its mechanical behaviour, depending on whether it is subjected to slow pressure or rapid impact. More specifically, when you press with your finger, the material will remain soft and malleable, like normal rubber. However, if you strike the material violently, the components of the D3O[®] will bond together to form a barrier against the shock and vibration, before returning to its soft state.

SAS-TEC
body protection systems

RACER[®] x SAS-TEC

Pour ses protections, Racer travaille également avec un autre acteur Européen majeur de la protection corporelle : la société Allemande SAS-TEC. Créée en 2004, elle fournit Racer depuis 2015 pour la conception d'une partie de ses protections vélos et notamment les gilets et genouillères. Le matériau qu'ils conçoivent est viscoélastique avec mémoire de forme c'est-à-dire que lors d'un choc la matière va se déformer et se durcir pour absorber l'énergie de l'impact puis reprendre sa forme d'origine et tout cela en un temps extrêmement rapide. C'est l'air contenu dans les cellules qui composent la matière qui est responsable de ce tour de force et qui absorbe progressivement le choc selon la violence de celui-ci. En cela, on retrouve des similitudes avec le D3O[®]. Ce n'est d'ailleurs pas pour rien qu'ils sont tous deux des acteurs incontournables lorsqu'il s'agit de protections corporelles.

For its protective gear, Racer also works with another major European player in body protection: the German company SAS-TEC. Created in 2004, it has been supplying Racer since 2015 with designs for some of its bicycle protection products, in particular the jackets and knee pads. The material they design is viscoelastic with shape memory, which means that during an impact, the material will become distorted and rigid to absorb the energy of the impact, and then return to its original shape, all in an extremely short period of time.

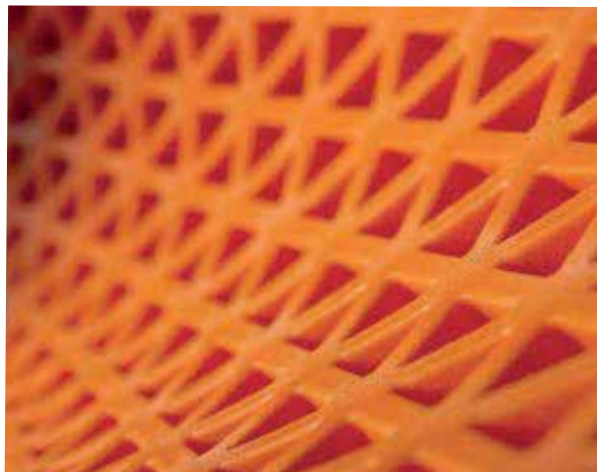

KENNY

COLLECTION 2023



KENNY

HELMETS 2023

Decade



Sizes: XXS > XL



SOLID BLACK
232-2007050-09



LUNIS CANDY PURPLE
232-2007050-14



LUNIS CANDY EMERAUDE
232-2007050-05



LUNIS BLACK HOLOGRAPHIC
232-2007050-33



LUNIS WHITE GOLD
232-2007050-30



SUNRISE
232-2007050-16



SHIELD
232-2007050-94



SMASH CANDY BLUE
232-2007050-90



SMASH BLACK TUROUISE
232-2007050-02



SMASH NEON YELLOW ORANGE
232-2007050-31



SMASH PATRIOT
232-2007050-28

Decade I



Sizes: XXS > XL



SOLID BLACK
212-2007051



Decade II



Sizes: XXS > XL



LUNIS GREY
212-2007050

Downhill



Sizes: XXS > XL



RED
232-2003031-01



NEON YELLOW
232-2003031-97



ORANGE
232-2003031-06



HOLOGRAPHIC BLACK
232-2003031-34



SILVER
232-2003031-03



PRISME
232-2003031-14



NAVY
232-2003031-20



BLUE
232-2003031-02



PATRIOT
232-2003031-28



SOLID MATT BLACK
232-2003032

Downhill II



Sizes: XXS > XL



CANDY BLUE
222-2003031-90



ORANGE
222-2003031-06



NAVY
222-2003031-20



NEON YELLOW
222-2003031-97



PATRIOT
222-2003031-28



DARK BLUE
222-2003031-02



DARK GREEN
222-2003031-05

Downhill solid



Sizes: XXS > XL
ref: 202-2003032-09



SOLID MATT BLACK

HELMETS

KENNY

Split



Sizes: S > XL



GRAPHIC RED
232-3007050-01



DARK BLUE
232-3007050-48



GREY
232-3007050-03



BLACK
212-3007050-09



WHITE BLACK
232-3007050-00



GRAPHIC DARK GREEN
232-3007050-05



RED WHITE
212-3007050-02



GRAPHIC GREY
232-3007050-48



GREY BLACK
212-3007050-03



BLACK
232-3007050-09



WHITE BLACK
212-3007050-00

Rafale



Sizes: S > XL



SAGE GREEN
222-2007070-05



BLACK
222-2007070-09



GREY
222-2007070-03



GRADIENT
232-2007070-66



DARK RED
232-2007070-87



GREY ORANGE
232-2007070-03



DARK GREEN
232-2007070-05



DARK BLUE
222-2007070-02



WHITE RED
232-2007070-62

Konnect



Sizes: S/M - L/XL
ref: 182-2004060



Rocket



Sizes: S > XL



DARK BROWN
232-2008070-30



DARK BLUE
232-2008070-02



DARK GREY PEARL
232-2008070-49



GREY
232-2008070-03



BLACK
232-2008070-09



WHITE GREY
232-2008070-00

Scrambler



Sizes: S/M - L/XL

Size: XS (kid)



BLUE ORANGE
222-2007060-29
KID 232-2007060-29



GREEN
222-2007060-05



GREY RED
222-2007060-01
KID 232-2007060-01



GREY
222-2007060-03



BLACK
222-2007060-09
KID 232-2007060-09



WHITE
222-2007060-00
KID 232-2007060-00

K-One



Sizes: S/M - L/XL



BORDEAUX
212-2004040-01



MINERAL
232-2004040-02



DARK BLUE
212-2004040-02



DARK GREEN
212-2004040-05



GREY ORANGE
212-2004040-03



BLACK
212-2004040-09



WHITE
212-2004040-00

Furtif



Sizes: S/M - L/XL



RED
232-2005010-01



CANDY PURPLE
232-2005010-14



NEON YELLOW
232-2005010-97



BLACK
232-2005010-09



WHITE
232-2005010-00

KENNY

GOGGLES 2023

Ventury

Size: ONE SIZE

PHASE 1  



NAVY WHITE
201-0712021-20



NEON YELLOW
201-0712021-97



BLACK
201-0712021-09



WHITE
201-0712021-00

PHASE 2   



RED YELLOW
221-0712022-01



RED
201-0712022-01



ORANGE BLACK
221-0712022-48



NAVY CYAN
201-0712022-38



SILVER
221-0712022-45



BLACK
201-0712022-09



WHITE SILVER
201-0712022-27

Performance Level 1



Size: ONE SIZE



BLACK
201-0702010

Performance Level 2

Size: ONE SIZE



GOLD
221-0702011-30



NEON YELLOW
221-0702011-97



BLUE RED
221-0702011-28



RED
221-0702011-01



ORANGE
221-0702011-06



CANDY BLUE
221-0702011-02



CANDY RED
221-0702011-27



NAVY NEON YELLOW
221-0702011-32



BLACK
201-0702011-09



WHITE
201-0702011-00

Track +

Size: ONE SIZE



RED
221-0803011-01



CYAN
221-0803011-43



NEON YELLOW
221-0803011-97



NEON PINK
221-0803011-80



ORANGE
221-0803011-06



BLACK
221-0803011-09

Track



Size: ONE SIZE



BLACK
221-0803014-09



WHITE
221-0803014-00

Track + Kid

Size: ONE SIZE



RED
221-0803012-01



NEON YELLOW
221-0803012-97



ORANGE
221-0803012-06

Track Kid

Size: ONE SIZE



BLACK
221-0803013

KENNY

OUTFITS 2023

Evo pro



JERSEY
Sizes: S > XXL

KID JERSEY
Sizes: XXS > XS



JERSEY FOG
232-3004031
KID 232-3004033



JERSEY BLACK
222-3004031
KID 222-3004033-09

TROUSER
Sizes: 28 > 36 US
ref: 222-9007030



KID TROUSER
Sizes: 24 > 28 US
ref: 222-9007032

Prolight



JERSEY
Sizes: S > XXL

KID JERSEY
Sizes: XXS > XS



JERSEY KAKI
232-3004042-88



JERSEY DARK RED
232-3004042-87
KID 232-3004051-87



JERSEY LIME BLACK
232-3004042-75
KID 232-3004051-75



JERSEY BLACK GREY
232-3004042-49



JERSEY HOLOGRAPHIC
232-3004042-09
KID 232-3004051-09

TROUSER
Sizes: 28 > 36 US

KID TROUSER
Sizes: 24 > 28 US



TROUSER KAKI
232-6600030-88



TROUSER DARK RED
232-6600030-87
KID 232-6600032-87



TROUSER LIME BLACK
232-6600030-75
KID 232-6600032-75



TROUSER BLACK GREY
232-6600030-49



TROUSER HOLOGRAPHIC
232-6600030-09
KID 232-6600032-09

Elite



JERSEY
Sizes: S > XXL

KID JERSEY
Sizes: XXXXS > XS



JERSEY CAMO WHITE
232-3004040-00



JERSEY CAMO RED
232-3004040-01



JERSEY CAMO BLUE
232-3004040-02



JERSEY NAVY
232-3004040-20
KID 232-3004043-20



JERSEY BLACK
232-3004040-09
KID 232-3004043-09

TROUSER
Sizes: 28 > 36 US

KID TROUSER
Sizes: 18 > 28 US



TROUSER BLACK
232-6600020-09



TROUSER RED
232-6600020-01



TROUSER BLUE
232-6600020-02



TROUSER NAVY
232-6600020-20
KID 232-6600032-20



TROUSER BLACK
232-6600020-09
KID 232-6600032-09

Jacket Mtb

Sizes: S > XXL
ref: 222-2701000



Reflex



JACKET
Sizes: S > XXL
ref: 232-3004060

TROUSER
Sizes: 28 > 36 US
ref: 232-9004060



Master



JACKET
Sizes: S > XXL
ref: 212-3004020

TROUSER
Sizes: 28 > 36 US
ref: 212-9004021



OUTFITS

charger



JERSEY
Sizes: S > XXL

T-SHIRT
Sizes: S > XXL



SHORT
Sizes: 28 > 38 US



T-SHIRT DYE BLUE
232-3005040-02



T-SHIRT DYE KAKI
232-3005040-88



T-SHIRT FLORAL GREEN
232-3005040-05



T-SHIRT FLORAL BLACK
232-3005040-09



SHORT ORANGE
222-2905050-48



SHORT KAKI
232-2905050-88



SHORT BLUE
232-2905050-02



JERSEY DYE BLUE
232-3005050-02



JERSEY DYE KAKI
232-3005050-88



JERSEY FLORAL GREEN
232-3005050-05



JERSEY FLORAL BLACK
232-3005050-09



SHORT GREEN
232-2905050-05



SHORT BLACK
222-2905050-09



SHORT GREY
232-2905050-03

charger women



JERSEY
Sizes: XS > XL



SHORT
Sizes: 28 > 36 US



JERSEY BLACK
232-2204040-09



JERSEY DYE
232-2204040-90



JERSEY FLOWER
232-2204040-40



JERSEY KAKI
232-2204040-88



SHORT BLACK
222-2504040-09



SHORT NAVY
222-2504040-20



SHORT KAKI
222-2504040-88

Factory



JERSEY
Sizes: S > XXL

SHORT
Sizes: 28 > 38 US



KID JERSEY
Sizes: XXS > XS

SHORT KID
Sizes: 24 > 28 US



JERSEY DARK RED
232-3002222-87
KID 232-3002232-87



JERSEY NAVY ORANGE
232-3002222-26
KID 232-3002232-26



JERSEY BLACK GREY
232-3002222-49



JERSEY PETROL YELLOW
232-3002222-02



SHORT DARK RED
232-3002020-87
KID 232-3002022-87



SHORT NAVY ORANGE
232-3002020-26
KID 232-3002022-26



SHORT BLACK GREY
232-3002020-49



SHORT PETROL YELLOW
232-3002020-02

Root



T-SHIRT
Sizes: S > XXL

SHORT
Sizes: 28 > 38 US



T-SHIRT ROOT BLUE
232-3002230-02



T-SHIRT ROOT BLACK
232-3002230-09



SHORT ROOT
232-2905060

Indy



T-SHIRT INDY
Sizes: S > XXL



T-SHIRT INDY NEON
232-3002525-66



T-SHIRT INDY SUN
232-3002525-73



T-SHIRT INDY CAMO
232-3002525-92

Gravity



SHORT GRAVITY
Sizes: 28 > 40 US



SHORT GRAVITY NAVY
232-3002030-20



SHORT GRAVITY BLACK
232-3002030-09

Enduro



SHORT ENDURO
Sizes: 28 > 38 US



SHORT ENDURO BLUE
222-3001011-02



SHORT ENDURO BLACK
212-3001011



SHORT ENDURO GREY
222-3001011-03

Escape summer



T-SHIRT
Sizes: S > XXL



T-SHIRT BLACK
232-2301031-09



T-SHIRT KAKI
232-2301031-88



T-SHIRT DZR
232-2301031-89



T-SHIRT BLACK
222-2301031-09

BIB SHORT
Sizes: S > XXL
ref : 222-2301032



Escape winter



JERSEY
Sizes: S > XXL



JERSEY RED
222-1301031-01



JERSEY KAKI
222-1301031-88



JERSEY GREY
222-1301031-03



JERSEY RAW BLACK
222-1301031-09



JERSEY ORANGE
222-1301031-06

LEGGING
Sizes: S > XXL
ref : 222-1301032



Tech summer



T-SHIRT
Sizes: S > XXL



T-SHIRT RED
232-3001031-01



T-SHIRT BLACK WHITE
232-3001031-33



T-SHIRT DYE RED
232-3001031-93



T-SHIRT DYE BLUE
232-3001031-02
KID 232-2601052

BIB SHORT
Sizes: S > XXL
ref : 212-3301032



KID T-SHIRT
Sizes: 8 / 10 / 12 years old

KID BIB SHORT
Sizes: 8 / 10 / 12 years old
ref : 212-3301042

Tech winter



JACKET
Sizes: S > XXL
ref : 212-2601061



JERSEY
Sizes: S > XXL
ref : 212-2601051



LEGGING
Sizes: S > XXL
ref : 212-3201012



KID JACKET
Sizes: 8 / 10 / 12 years old
ref : 212-2601062

KID JERSEY
Sizes: 8 / 10 / 12 years old
ref : 212-2601082

KID LEGGING
Sizes: 8 / 10 / 12 years old
ref : 212-3301022

GLOVES 2023

Rock



Sizes: 7 > 13
ref : 232-3008000



Root



Sizes: 7 > 13
ref : 232-3001020



Escape



Sizes: 7 > 13
ref : 232-3001080



UP



Sizes: 6 > 13



BLACK
221-2508011-09



RED
221-2508011-01



BLUE
221-2508011-02



NEON YELLOW
221-2508011-97

Gravity



Sizes: 7 > 12



GREY NEON YELLOW
212-3009010-03



GREEN
232-3009010-05



RED
232-3009010-01



BLACK
212-3009010-09



BLACK
232-3009010-09



TIE BLUE
232-3009010-02



TIE KAKI
232-3009010-88

GLOVES

KENNY

Track



Sizes: 7 > 13
KID Sizes: 2 > 6



BLACK
231-2803011-09
KID 231-2803202-09



RED
231-2803011-01
KID 231-2803202-01



BLACK NEON YELLOW
231-2803011-46
KID 231-2803202-46



BLACK ORANGE
231-2803011-48
KID 231-2803202-48



NAVY
231-2803011-20
KID 231-2803202-20



RED NAVY
231-2803011-28



NAVY NEON YELLOW
231-2803011-32
KID 231-2803202-32

Brave



Sizes: 7 > 12

KID Sizes: 2 > 6



BLACK
231-2904011-09



RED
231-2904011-01



ORANGE
231-2904011-06



BLUE
231-2904011-02



NEON YELLOW
231-2904011-97

Race



Sizes: 5 > 13



WHITE
232-3006020-00



BLACK
232-3006020-09

Storm



Sizes: 7 > 13
ref: 211-2702011



Winter



Sizes: 7 > 13
ref: 202-3008020



Muddy



Sizes: 7 > 13
ref: 201-3001011



Warm



Sizes: 7 > 13
ref: 172-4707090



PROTECTIONS 2023

Rock



Sizes: XS > XXL
ref: 232-2003050



Rock whitout sleeves



Sizes: XS > XXL
ref: 232-2003040



Performance



Sizes: S > XXXL
ref: 231-1702010



Track



Sizes: S > XXXL
ref: 231-1702011

KID Sizes: S > L
ref: 231-1702222



Kontakt



Sizes: 3XS/2XS, XS/S,
M/L, XL/XXL
ref: 182-2002011

KID Sizes: XS/S, M/L
ref: 182-2002012



Reflex



Sizes: S > XXL
ref: 202-2002020

KID Sizes: S > L
ref: 212-2002021



Mission chest protector



Sizes: S/M, L/XL
ref: 201-1901010



Tracer



Sizes: S > XXXL
ref: 192-2003020



UNDER SHORT

Rock



Sizes: S > XXL
ref: 231-1701010



KNEE GUARDS

Proflex



Sizes: S > XL
ref: 232-2515020



Rock



Sizes: XS/S, M/L, XL/XXL
ref: 232-2515030



Hexa



Sizes: XS/S, M/L, XL/XXL
ref: 232-2515001



Reflex



Sizes: S > XL
ref: 222-2515020



Kontakt



Sizes: XS > XL
ref: 202-2515001 (XS)
ref: 202-2515002 (S > XL)



Knee guards



Size: ONE SIZE
ref: 231-2515040

KID Size: ONE SIZE
ref: 231-2515042



Kontakt



Sizes: XXS/XS, XS/S, S/M
ref: 202-2515003



NECK PRO-TECTOR



Size: ONE SIZE
ref: 161-1515011

KID Size: ONE SIZE
ref: 161-1515202



ELBOWS GUARDS

Hexa



Sizes: XS/S, M/L, XL/XXL
ref: 232-2315001



Elbows guards



Size: ONE SIZE
ref: 231-2315040

KID Size: ONE SIZE
ref: 231-2315042



LUGGAGES 2023

Helmet bag

Size: ONE SIZE
ref: 201-6317011



Goggles bag

Size: ONE SIZE
ref: 211-6417021



Rain coat

Sizes: M/L - XL/XXL
ref: 151-6304031



Back pack

Size: ONE SIZE
ref: 211-6117011



Camel Bag

Size: ONE SIZE
ref: 211-6117021



WATER BAG 2L
ref: 071-6117019



Bumbag

Size: ONE SIZE
ref: 211-6217021



Can



Size: ONE SIZE
ref: 202-1001010



Umbrella



Size: ONE SIZE
ref: 231-9920011



KENNY

SPORTSWEAR 2023

ACADEMY



SWEAT HYBRIDE
 Sizes: S > XXL
 ref: 231-4601042



BODYWARMER
 Sizes: S > XXL
 ref: 231-7706011



CARDIGAN
 Sizes: S > XXL
 ref: 231-4603030



HOODIE
 Sizes: S > XXL



NAVY
 231-4601044-20



KAKI
 231-4601044-88



POLO
 Sizes: S > XXL



NAVY
 231-4706016-20



KAKI
 231-4706016-88



T-SHIRT
 Sizes: S > XXL



WHITE
 231-5004041-00



NAVY
 231-5004041-20



KAKI
 231-5004041-88



CAP
 Size: ONE SIZE



WHITE
 231-4106032-00



NAVY
 231-4106032-20



SWEAT ZIPPED WOMEN
 Sizes: S > XL
 ref: 231-4601045



T-SHIRT WOMEN
 Sizes: S > XL



WHITE
 231-5004042-00



NAVY
 231-5004042-20

CORE



SOFTSHELL
 Sizes: S > XXXL



BLACK
 231-7806016-09



NAVY
 231-7806016-20



SWEAT
 Sizes: S > XXXL



BLACK
 231-4601041-09



NAVY
 231-4601041-20



KAKI
 231-4601041-88



CAP
 Size: ONE SIZE



CORE
 231-4106032-88



BEANIES
 Size: ONE SIZE



LABEL BLACK
 231-4106000-09



LABEL GREY
 231-4106000-03



LABEL KAKI
 231-4106000-88

BLACK LINE

JACKET
 Sizes: S > XXXL
 ref: 221-7906000



SWEAT
 Sizes: S > XXL
 ref: 221-4602020



JOGGING
 Sizes: S > XXL
 ref: 221-4800000



Paddock

PARKA
Sizes: S > XXXL
ref: 221-4506020



SOFTSHELL
Sizes: S > XXXL
ref: 221-7806015



KID
SWEAT
Sizes: S > XXXL
ref: 221-4601040



KID Sizes: 6, 8, 10 and 12yo
ref: 231-4601046

POLO
Sizes: S > XXXL
ref: 221-4706015



KID
T-SHIRT
Sizes: S > XXXL
ref: 221-5006305



KID Sizes: 6, 8, 10 and 12yo
ref: 231-5006306

RACING

PADDED JACKET
Sizes: S > XXXL
ref: 211-4506020



JACKET
Sizes: S > XXXL
ref: 211-4506010



BOMBERS
Sizes: S > XXL
ref: 191-4506020-09



SHORT
Sizes: 30 > 40 US
ref: 221-6006021



TROUSER
Sizes: 30 > 40 US
ref: 221-6006011



NEW
MECA TROUSER
Sizes: 30 > 40 US
ref: 231-6002021



MEN

T-SHIRT
Sizes: S > XXL



DIVISION
221-5005041-00



GLITCH
221-5005041-03



HELMET
221-5005041-72



UXA
221-5005050-03



RETRO BLACK
221-5005060-09



RETRO ECRU
221-5005060-58

WOMEN

T-SHIRT
Sizes: S > XL



RETRO
221-5006032



RAINBOW WHITE
211-5006032-00



RAINBOW BLACK
211-5006032-09



LABEL GREY
211-5006033-05



LABEL BURGUNDY
211-5006033-89

SOCKS

Sizes: 39/42, 43/46



RED
222-4906011-01



KAKI
222-4906011-88



BLUE
222-4906011-02



BLACK
222-4906011-09



WHITE
222-4906011-00



**WE LOOK FOR
INNOVATIVE
SOLUTIONS
FOR YOUR
ENJOYMENT**

SPRAYKE®

WWW.SPRAYKE.COM

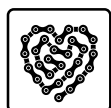

LUBRICAT

OLIO PER BICI

- Lubrificante catene bici
- Resistente all'acqua
- **Non contiene solventi**
- Lunga durata
- Contiene P.T.F.E.

OIL FOR BICYCLES

- Lubricant for bikes' chains
- Water resistant
- **Solvents free**
- Long lasting
- It contains P.T.F.E.

	FORMAT	CODE	BOX OF
SPRAY	200 ML	16010/02	12



SPECIAL LUBE

LUBRIFICANTE PER CATENE

- Manutenzione ciclo
- Compatibile con i movimenti meccanici
- Incolore, idrorepellente
- Contiene P.T.F.E.

CHAIN LUBRICANT

- For cycles maintenance
- Compatible with mechanical movements
- Colorless, water repellent
- It contains P.T.F.E.

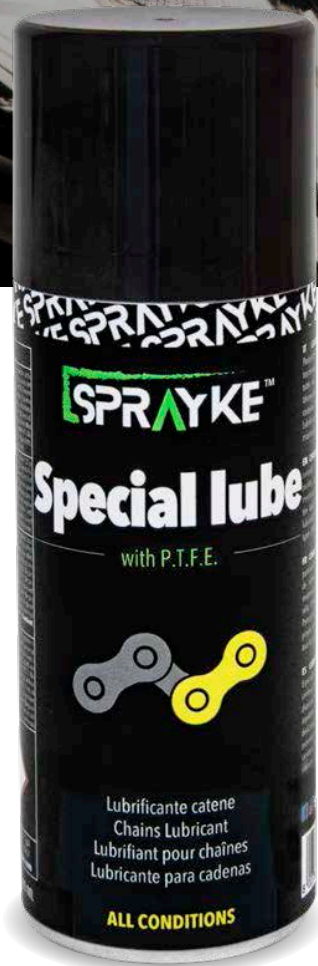

	FORMAT	CODE	BOX OF
SPRAY	200 ML	13410/02bike	12



LUBE 1

LUBRIFICANTE CATENE

- Lubrificante di elevate prestazioni per tutte le condizioni
- Indicato per catene, trasmissioni, pedali.
- Protettivo e idrorepellente
- **Non attira lo sporco**
- Efficace per tutte le tipologie di bicicletta: Strada, Mountain-bike, City bike ed E-bike
- Lubrifica sotto forte attrito
- Contiene P.T.F.E. e cere

CHAIN LUBRICANT

- *High performances lubricant for all conditions*
- *Indicated for: chains, transmissions, pedals.*
- *Protective and water repellent*
- **It does not attract dirt**
- *Effective lubrication for all types of bicycles: road, mountain bike, city bike and E-bike*
- *Lubricates in strong friction conditions*
- *It contains P.T.F.E. and wax*

	FORMAT	CODE	BOX OF
DROPPER	120 ML	60480/100	12
REFILL	1 LT	60480/01	6



1 LT REFILL

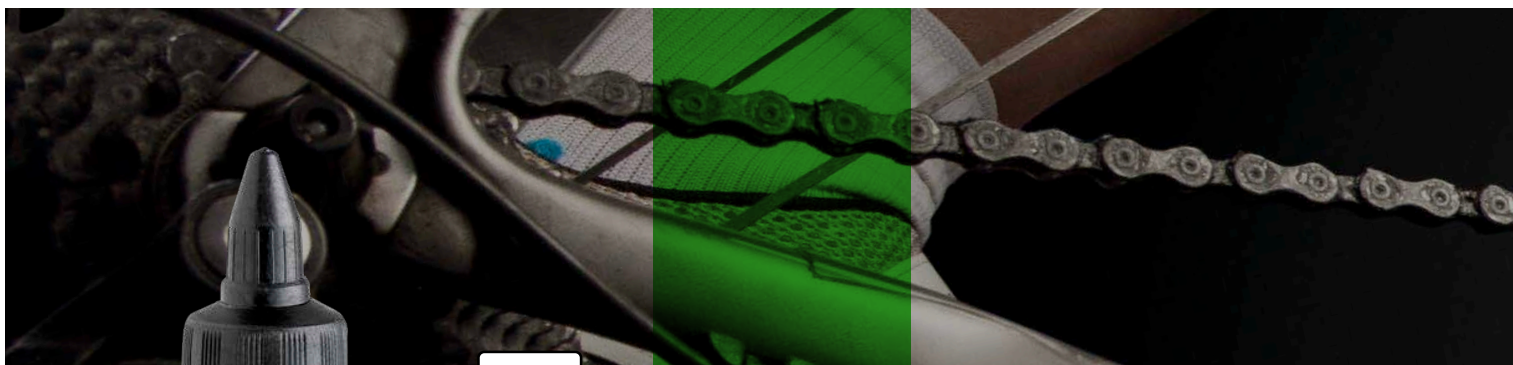
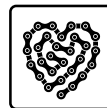

LUBE 2

LUBRIFICANTE CATENE

- Lubrificante di elevate prestazioni per condizioni bagnate e lunghe percorrenze
- Indicato per catene, trasmissioni, pedali.
- Protettivo e idrorepellente
- Efficace per tutte le tipologie di bicicletta: Strada, Mountain-bike, City bike ed E-bike
- Esente da solventi
- Base rinnovabile

CHAINS LUBRICANT

- *High performance lubricant for wet conditions and long rides*
- *Suitable for chains, transmissions, pedals*
- *Protective and water repellent*
- *For all types of bicycles: road, mountain bike, city bike and E-bike*
- *Solvent free*
- *Renewable bases*



	FORMAT	CODE	BOX OF
DROPPER	120 ML	60280/120	12



SUSPENSION LUBE

LUBRIFICANTE PER SOSPENSIONI

- Lubrifica steli e tenute di forcelle, ammortizzatori e reggisella telescopici
- Aumenta la scorrevolezza e le performance delle sospensioni
- Protettivo e idrorepellente
- Preserva la gomma dall'invecchiamento precoce
- Lunga durata

LUBRICANT FOR SUSPENSIONS

- Lubricates stems and seals on forks, shock absorbers and telescopic seatposts
- Increases smoothness and suspension performance
- Protective and water repellent
- Preserves rubber from premature ageing
- Long lasting

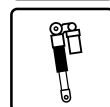
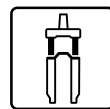

	FORMAT	CODE	BOX OF
SPRAY	200 ML	16110/02 SUSPENSION	12



PK

LUBRIFICANTE MULTIUSO

- Per tutte le tipologie di biciclette
- Lubrificante
- Sbloccante
- Penetrante
- Detergente
- Idrorepellente
- Protettivo
- Biodegradabile

MULTIPURPOSE LUBRICANT

- For all types of bicycles
- Lubricant
- Releasing agent
- Penetrant
- Detergent
- Water-repellent
- Protective
- Biodegradable

	FORMAT	CODE	BOX OF
SPRAY	400 ML	11710/04PK- SMARTbike	12

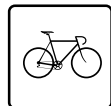

AIR LATEX

GONFIA E RIPARA CON CONNETTORE RAPIDO

- Prodotto specifico per riparare e rigonfiare istantaneamente tutti i tipi di biciclette
- Prodotto a base di lattice di gomma, senza ammoniaca
- Connettore rapido di facile utilizzo per valvole Presta e Woods
- Tubeless o con camera d'aria

INFLATE AND REPAIR FOR BICYCLES WITH QUICK CONNECTOR

- Specific for quick repair and inflate all types of bicycles
- Product based on rubber latex, ammonia-free.
- Easy to use quick connector for Presta and Woods valves
- Tire types: road or MTB tubeless or with inner tube

	FORMAT	CODE	BOX OF
SPRAY	100 ML	60310/01	12

LATEX 1

SIGILLANTE PER PNEUMATICI TUBELESS

- Compatibile per tubeless, Tubeless ready e tubolari
- Azione veloce
- Ottimale per l'uso con i supporti antiforatura
- **Senza ammoniaca**
- Eco compatibile
- Non macchia: facilmente removibile
- Molto fluido

	FORMAT	CODE	BOX OF
BOTTLE	200 ML	60380/200	6
BOTTLE	1 LT	60380/01	6
DRUM	5 LT	60380/05	2

TUBELESS TYRE SEALANT

- Suitable for tubeless, tubeless-ready and tuboral
- Rapid action
- Ideal anti-puncture supports
- **Ammonia free**
- Eco-compatible
- It does not stain: easy to remove
- High fluidity

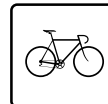
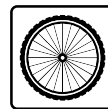

PULISUPER

PULITORE TELAI IN CARBONIO

- Schiuma attiva igienizzante
- Ideale anche per vernici opache
- Formulato per carbonio e alluminio
- Pulisce
- Lucida
- Protegge
- Telai ciclo e MTB
- Senza risciacquo
- **Biodegradabile**

CARBON FRAME CLEANER

- Active hygienizing foam
- Ideal for opaque paints too
- Formulated for carbon and aluminum
- Cleaner
- Glossy
- Protects
- For cycles and MTB frames
- Waterless cleaner
- **Biodegradable**

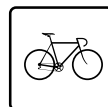

	FORMAT	CODE	BOX OF
SPRAY	400 ML	13510/04bike	12

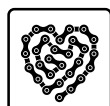

PULITEL

DETERGENTE BICI

- Pulisce e sgrassa il telaio
- Idrorepellente
- Protettivo antiossidazione
- Elimina sporco difficile
- Anche per carbonio

BIKE CLEANER

- It cleans and degrease the frame
- Water repellent
- Protective antioxidation
- It removes dirt difficult to be eliminated
- Suitable for carbon frames

	FORMAT	CODE	BOX OF
SPRAY	400 ML	16210/04	12



PULIFREN

PULITORE FRENI

- Migliora il funzionamento del tuo impianto frenante
- Sgrassatore universale
- Sgrassante veloce
- Elimina sporco, grasso, catrame e colla
- Non lascia residui
- Non intacca gomma o plastica

UNIVERSAL DEGREASER

- Improve performance of breaking system
- Universal degreaser
- Fast Degreaser
- It removes dirt, grease, tar and glue
- It does not leave residuals
- It does not damage rubber and plastic

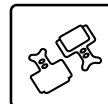

	FORMAT	CODE	BOX OF
SPRAY	500 ML	13810/05bike	12



PULISIL

DETERGENTE E PROTETTIVO

- Specifico per contatti e-bike
- Da utilizzare su connettori e contatti
- Non intacca gomma e plastiche
- Lascia un velo protettivo sulle superfici trattate
- Pulisce e ripristina contatti e sensori
- Idrorepellente

CLEANER AND PROTECTIVE

- For electrical and electronic contacts of e-bikes
- To be used on connectors and contacts
- It does not affect plastics
- It leaves a protective film on the treated surfaces
- Cleans and restores contacts and sensors
- De-watering

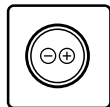
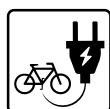

	FORMAT	CODE	BOX OF
SPRAY	200 ML	15710/02bike	12

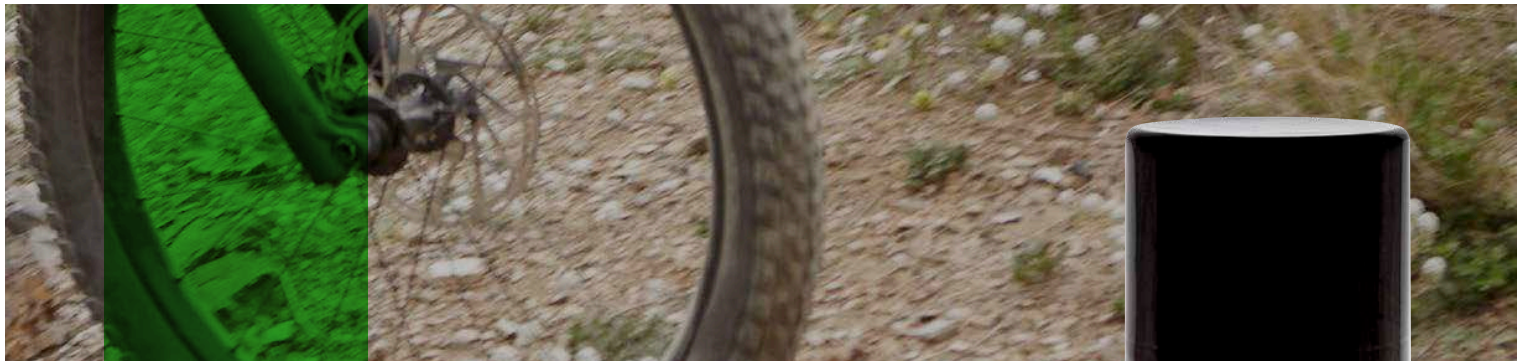

SILTEL

LUCIDANTE BICI

- Protegge dall'ossidazione
- Riduce l'adesione dello sporco
- Ideale anche per carbonio
- Lucida il telaio
- Repellente antifango
- Toglie righe e opacità

BICYCLES POLISH

- It protects against oxidation
- It reduces the adhesion of dirt
- Ideal for carbon-frames
- It polishes the frame
- Mud repellent
- It removes lines and opacity



	FORMAT	CODE	BOX OF
SPRAY	200 ML	16110/02	12



SUPER CLEANER

DETERGENTE SGRASSANTE

- Pulisce senza fatica
- Per tutti i componenti della bici
- Non intacca la vernice
- Compatibile con carbonio
- Protettivo / Brillantante
- **Biodegradabile**

DEGREASING, DETERGENT

- Easy cleaning
- For all bike components
- It does not affect the paint
- Carbon compatible
- Protective / Shining Agent
- **Biodegradable**

	FORMAT	CODE	BOX OF
TRIGGER	750 ML	40650/75bike	12
REFILL	750 ML	40650/75bikeR	12
DRUM	5 LT	40650/05bike	2



REFILL
750 ML



DRUM
5 LT

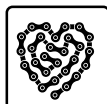
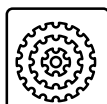
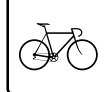
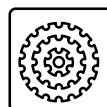

FOAM PUMP

POMPA FORMASCHIUMA

- Da abbinare al nostro SUPER CLEANER
- Per tutte le tipologie di bicicletta
- Ottimizza l'utilizzo del detergente
- Permette la diluizione del prodotto
- Forma una schiuma attiva

FOAMER PUMP

- To be combined with our SUPER CLEANER
- For all types of bicycles
- Optimize the use of detergent
- Allows product dilution
- Forms an active foam

	FORMAT	CODE	BOX OF
SPRAYKE FOAM PUMP	1500 ML	00004	8



SILICONI COMMERCIALE® SPA da sempre crea e produce Spray per la cura della Bici e, grazie alla Passione per questo sport, il Team Siliconi ha creato una gamma dedicata a bike & e-bike; con l'obiettivo di continuare a sviluppare nuovi prodotti sempre più **Eco-compatibili, Altamente Performanti ed Attenti alle necessità dell'utilizzatore.**

SILICONI COMMERCIALE® SPA è azienda leader nella produzione di SPRAY TECNICI. Nata nel 1957, si è distinta nel mercato per la novità degli articoli proposti.

- Un'area di 40.000 mq
- Impianti di produzione moderni
- Laboratori attrezzati per Ricerca e Sviluppo di nuovi prodotti
- Vasta gamma di prodotti di Elevata Qualità
- Un Team di persone giovani, dinamiche, propositive, altamente qualificate

SILICONI COMMERCIALE SPA has always created and produced sprays for bike care and, thanks to the passion for this sport, Siliconi's Team has created a special range dedicated specifically to the bike and e-bike with the aim of continuing to develop new products more and more **Eco-friendly, Highly Performing, Attentive to the user's needs.**

SILICONI COMMERCIALE® SPA is a leader company in the production of TECHNICAL SPRAYS. Established in 1957, over the years Siliconi Commerciale has made itself known in the market for its innovative products.

- An area of 40,000 square meters
- Modern production facilities
- Laboratories equipped for Research and Development of new products
- Wide range of High Quality products
- A team of young, dynamic, proactive, highly qualified people



RESEARCH FOR A SUSTAINABLE FUTURE



TRIBE

NUOVA SEDE

San Michele Mondovì (CN)



SHOWROOM

FLYER **TRANSITION** **superior.** **ACEPAC** **GRANITE** **RACER** **KENNY**



CENTRO FORMAZIONE **FIT**
E-BIKE SYSTEM
INTEGRATION



SHOWROOM UFFICIALE
FLYER

Join the TRIBE!

WWW.TRIBEDISTRIBUTION.COM

Richiedi l'accesso al nostro B2B
service@tribedistribution.com





TRIBE DISTRIBUTION s.r.l.
Via Nazionale, 12
12080 - San Michele Mondovì (CN)
TEL: 0171.330152
INFO@TRIBEDISTRIBUTION.COM
WWW.TRIBEDISTRIBUTION.COM